

LIVING

2022

TAVOLI E MADIE
TABLES AND SIDEBORDS



Target
POINT

Italian Ideas

LIVING 2022

TAVOLI E MADIE

tables and sideboards
tables et buffets
mesas y aparadores

Benvenuti nella Casa Target Point, benvenuti a Casa Vostra

Non esiste un'unica casa ideale, proprio per il concetto stesso che attribuiamo alla parola casa: un rifugio, una fortezza, un nido, un paradiso, un museo.

Ecco perché i nostri prodotti rispettano standard ben specifici: il design piacevole si deve combinare con la funzionalità e il comfort della praticità ad un prezzo accessibile.

Target Point nasce nel 1995 a Tezze sul Brenta tra le provincie di Vicenza, Padova e Treviso, nel cuore di un Veneto operoso e visionario. I primi articoli proposti erano tavolini con top in vetro temperato, a cui sono seguiti i letti in ferro battuto e successivamente, grazie ad un'intuizione dei soci, anche tavoli e sedie, divenuti, sin da subito, il vero core business dall'azienda.

Attraverso un'offerta sempre aggiornata in termini di tendenza e alla ricerca continua dell'alta qualità, da oltre vent'anni vogliamo offrirvi l'esperienza del vivere bene nel posto migliore al mondo, casa vostra. Senza nessun compromesso.

Vuoi conoscerci meglio?



Welcome to Target Point home, welcome to your home

There is not only one single ideal home, precisely because of the very concept that we give to the word home: a refuge, a fortress, a nest, a paradise, a museum.

The house becomes the practical expression of those who live it; this is why our products meet very specific standards: pleasant design must be combined with the functionality and comfort of practicality at an affordable price.

Target Point was founded in 1995 in Tezze sul Brenta, between the provinces of Vicenza, Padua and Treviso, in the heart of an industrious and visionary Venetia. The first items we proposed were coffee tables with tempered glass top, which were followed by iron beds and later tables and chairs, which immediately became the real core business of company.

Through an offer that is always updated in terms of trends and the continuous search for high quality, we want to offer you the experience of living well in the best place in the world, your home, without any compromise.

Want to know us better?



Bienvenus chez Target Point, bienvenus chez vous

Il n'y a pas une seule maison idéale, précisément à cause du concept que nous attribuons au mot maison : un refuge, une forteresse, un nid, un paradis, un musée.

La maison devient l'expression pratique de ceux qui la vivent, voilà pourquoi nos produits répondent à des normes très spécifiques : un design agréable doit être combiné avec la fonctionnalité et le confort de la praticité, à un prix abordable.

Target Point a été fondée en 1995 à Tezze sul Brenta, entre les provinces de Vicenza, Padoue et Trévis, au cœur d'une Vénétie travailleuse et visionnaire. Les premiers articles que nous avons proposés étaient des tables basses avec plateau en verre trempé, suivies par lits en fer et plus tard également de tables et de chaises, qui sont immédiatement devenues le véritable cœur de métier de l'entreprise.

A travers d'une offre toujours mise à jour en termes de tendances et recherche continue de haute qualité, nous voulons vous offrir l'expérience de bien vivre dans le meilleur endroit du monde, votre maison, sans aucun compromis.

Envie de mieux nous connaître ?



Bienvenido a la casa de Target Point, bienvenido a tu casa

No hay solamente una casa ideal, precisamente por el concepto que le damos nosotros a la palabra hogar: un refugio, una fortaleza, un nido, un paraíso, un museo.

La casa se convierte en la expresión práctica de quienes la viven, es por ello que nuestros productos cumplen con unos estándares muy específicos: un diseño agradable debe combinarse con la funcionalidad y comodidad de la practicidad a un precio asequible.

Target Point fue fundada en 1995 en Tezze sul Brenta, entre las provincias de Vicenza, Padua y Treviso, en el corazón de un laborioso y visionario Véneto. Los primeros artículos que propusimos fueron mesas de centro con encimera en cristal templado, a los que siguieron las camas de hierro y más tarde también mesas y sillas, que de inmediato se convirtieron en la propuesta principal de la empresa.

A través de una oferta siempre actualizada en cuanto a tendencias y a la búsqueda continua de la alta calidad, queremos ofrecer la experiencia de vivir bien en el mejor lugar del mundo, tu hogar, sin ningún compromiso.

Quieres conocernos mejor?



MISURA 200 cm o superiori

SIZE 200 cm or more / TAILLE 200 cm ou plus / TAMAÑO 200 cm o más



CRYSTAL PLUS

TAC01 P. 34

ECLIPSE

TA400 P. 24
TP405 P. 22
TP400 P. 26
TP407 P. 32
TP404 P. 32
TP403 P. 32

PRIAMO

TP162 P. 54
TP165 P. 58
TP158 P. 58
TP157 P. 58

TAURUS

TP163 P. 68
TP159 P. 74
TP161 P. 70
TP160 P. 74

ZED

TA202 P. 12
TP203 P. 16
TP204 P. 16
TP205 P. 16

MISURA 180 cm

SIZE 180 cm / TAILLE 180 cm / TAMAÑO 180 cm



APOLLO

TA1C3 P. 166

ASTERION

TA194 P. 156

COSMOS

TP1E2 P. 38

DELTA

TA519 P. 74

ECLIPSE

TA402 P. 18
TP402 P. 22



GIOVE

TA193 P. 194

GRECALE

TA1C1 P. 176

MARTE

TA147 P. 202

PONENTE

TA1A4 P. 190

PRIAMO

TA1A1 P. 46
TP1A1 P. 52



SIGMA

TA517 P. 146
TA521 P. 152

TAURUS

TA1A2 P. 60
TP1A2 P. 66

TWIST

TA204 P. 90

ZED

TA201 P. 10

MISURA 160 cm

SIZE 160 cm / TAILLE 160 cm / TAMAÑO 160 cm



APOLLO

TA1C4 P. 170

ASTERION

TA1C5 P. 162

CALICE

TA200 P. 92
TA202 P. 96

COPERNICO

TA196 P. 132

COSMOS

TA1E2 P. 40



CROSS

TA1E3 P. 114
TA1D6 P. 112
TA1D5 P. 110

DEIMOS

TA190 P. 212

DELTA

TA523 P. 78

ETTORE

TA1D8 P. 140

GIOVE

TA177 P. 198



MARTE

TA127 P. 204

MINOSSE

TA1E5 P. 122
TA1D3 P. 118

PONENTE

TA1A8 P. 186

POSEIDONE

TA1A0 P. 124

PRIAMO

TA1B1 P. 50



SATURNO

TA192 P. 228

SIGMA

TA522 P. 154

TAURUS

TA1E0 P. 66

TRITONE

TA516 P. 80

TWIST

TA204 P. 90
TA206 P. 86

VORTICE

TA1B9 P. 100

MISURA 140 E 130 cm

SIZE 140 cm and 130 cm / TAILLE 140 cm et 130 cm / TAMAÑO 140 cm y 130 cm



AURIGA

TA114 P. 260



BIBLOS

TA1D4 P. 254



CRONOS

TA1B0 P. 274



CROSS

TA1D6 P. 112



DEIMOS

TA191 P. 220

TAVOLI ROTONDI

Round tables / Tables rondes / Mesas redondas



AIACE

TA1E1 P. 282



CRONOS

TA1B0 P. 274
TP1B0 P. 278



FLUTE

TP116 P. 288

TAVOLI TRASFORMABILI

Transformable tables / Tables transformables / Mesas transformables



ENEAS

TA1D9 P. 242



OCEANO

TA1D0 P. 248



SATURNO

TA188 P. 234



TORNADO

TA1B5 P. 106



VORTICE

TA1B6 P. 102



DIONE

TA150 P. 290



ETTORE

TA1D8 P. 140



PANDORA

CO507 P. 294
CO506 P. 294
CO505 P. 298

MISURA 120 CM O INFERIORI

SIZE 120 cm or less / TAILLE 120 cm ou moins / TAMAÑO 120 cm o menos



AIACE

TA1E1 P. 282



AURIGA

TA114 P. 260



COPERNICO

TA184 P. 136



DEIMOS

TA1B7 P. 224



DIONE

TA150 P. 290



FLUTE

TP116 P. 288



PERIGEO

TA161 P. 264
TA159 P. 268



POSEIDONE

TA1A3 P. 126



SATURNO

TA1B2 P. 238



TUCANO

TP153 P. 272
TP152 P. 272

MADIE

Sideboards / Buffets / Aparadores

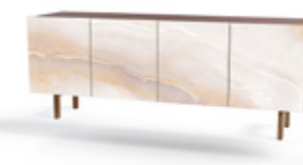

ARTEMIDE

MA115 P. 302



ASTRA

MA114 P. 356



ELECTA

MA103 P. 350



GIUNONE

MA112 P. 308



MINERVA

MA113 P. 360



MODUS

MA108 P. 320
MA110 P. 330



VERSUS

MA101 P. 340
MA100 P. 344



TAVOLI

tables / tables / mesas

ZED

TAVOLO ALLUNGABILE / EXTENDABLE TABLE
COD. TA201 - TOP 180/270X90 cm

Tavolo allungabile con basamento in agglomerato Spazzolato argento 3040 e piano in gres porcellanato effetto marmo Arabescato 3818.

Extendable table with Brushed silver 3040 agglomerate basement and Arabesque 3818 marble-effect porcelain stoneware top.

Table extensible avec piétement central en agglomerat Brossé argent 3040 et plateau en céramique effet marbre Arabesque 3818.

Mesa extensible con base central en aglomerado Cepillado plata 3040 y encimera en porcelánico efecto marmol Arabescato 3818.

Sedia/Chair/Chaise/Silla DIGIONE SE185.



ZED

TAVOLO ALLUNGABILE / EXTENDABLE TABLE
COD. TA201 - TOP 180/270X90 cm

Tavolo allungabile con basamento in agglomerato Spazzolato argento 3040 e piano in gres porcellanato effetto marmo Arabescato 3818.

Extendable table with Brushed silver 3040 agglomerate basement and Arabesque 3818 marble-effect porcelain stoneware top.

Table extensible avec piétement central en agglomerat Brossé argent 3040 et plateau en céramique effet marbre Arabesque 3818.

Mesa extensible con base central en aglomerado Cepillado plata 3040 y encimera en porcelánico efecto marmol Arabescato 3818.

FINITURE / Finishes

STRUTTURA / Frame
 agglomerato / agglomerate



3008
Bianco
White



3012
Bronzo
Bronze



3021
Grafite
Graphite



3039
Terra
Earth



3040
Spazzolato Argento
Silver Brushed



3004
Oro Opaco
Matt Gold



3010
Nero
Black

PIANO / Top
 gres lucido /
 glossy stoneware



3828
Carrara
Carrara



3816
Alabastro
Alabaster



3818
Arabescato
Arabesque



3660
Emperador
Emperador

PIANO / Top
 gres opaco /
 matt stoneware



3808
Calacatta
Calacatta

MISURE / Size

L 180/270 P 90 H 75 cm

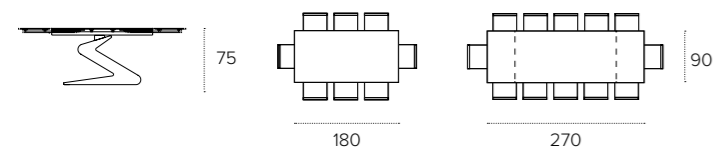

FINITURE / Finishes

STRUTTURA / Frame
 agglomerato / agglomerate



3008
Bianco
White



3012
Bronzo
Bronze



3021
Grafite
Graphite



3039
Terra
Earth



3040
Spazzolato Argento
Silver Brushed



3004
Oro Opaco
Matt Gold



3010
Nero
Black

PIANO / Top
 gres lucido /
 glossy stoneware



3828
Carrara
Carrara

MISURE / Size

COD. TP202 - TOP A BOTTICELLA 230X110 cm

L 230 P 110 H 75 cm

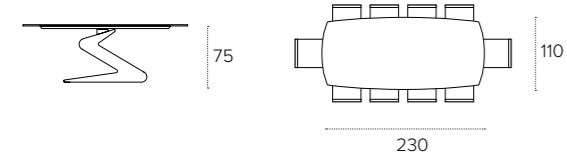

ZED

TAVOLO ALLUNGABILE / EXTENDABLE TABLE
COD. TA202 - TOP 200/300X100 cm

Tavolo allungabile con basamento in agglomerato Bronzo 8212 e piano in vetro temperato Trasparente 2001.
Extendable table with Bronze 8212 agglomerate central basement and Transparent 2001 tempered glass top.
Table extensible avec piètement central en agglomerat Bronze 8212 et plateau en verre trempé Transparent 2001.
Mesa extensible con base central en aglomerado Bronce 8212 y encimera en cristal templado Transparente 2001.

Sedia/Chair/Chaise/Silla DALLAS SE616.



FINITURE / Finishes

STRUTTURA / Frame
agglomerato / agglomerate



3008
Bianco
White



3012
Bronzo
Bronze



3021
Grafite
Graphite



3039
Terra
Earth



3040
Spazzolato
Brushed



3004
Oro
Gold



3010
Nero
Black

PIANO / Top
vetro temperato /
tempered glass



2001
Trasparente
Transparent

MISURE / Size

L 200/300 P 100 H 75 cm

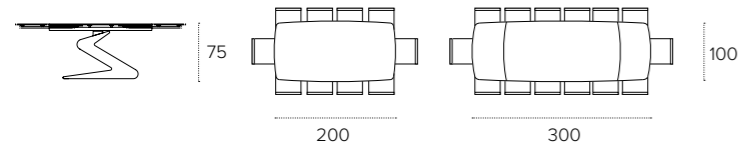

ZED

TAVOLO FISSO / NON-EXTENDABLE TABLE

COD. TP202 - TOP A BOTTICELLA 230X110 cm

COD. TP203 - TOP RETTANGOLARE 230X110 cm

COD. TP204 - TOP A BOTTICELLA 200X100 cm

COD. TP205 - TOP RETTANGOLARE 200X100 cm

Tavolo fisso con basamento in agglomerato e piano rettangolare o a botticella in legno impiallacciato.
Non-extendable table with agglomerate basement and rectangular or barrel-shaped veneered wood top.
Table fixe avec piètement central en agglomérat et plateau rectangulaire ou en forme de tonneau en placage bois.
Mesa fija con base central en aglomerado y encimera rectangular o en forma de barril en chapa de madera.

Sedia / chair / chaise / silla VIENNA SE608.

FINITURE / Finishes

STRUTTURA / Frame
agglomerato / agglomerate



3008
Bianco
White



3012
Bronzo
Bronze



3021
Grafite
Graphite



3039
Terra
Earth



3040
Spazzolato
Brushed



3004
Oro
Gold



3010
Nero
Black

PIANO / Top
impiallacciato legno /
veneered wood



1012
Noce
Walnut



1020
Piombo
Lead



1027
Rustico
Country



1071
Tabacco
Tobacco

MISURE / Size

COD. TP202 - TOP A BOTTICELLA 230X110 cm

L 230 P 110 H 75 cm

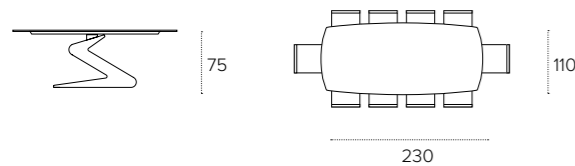

COD. TP203 - TOP RETTANGOLARE 230X110 cm

L 230 P 110 H 75 cm

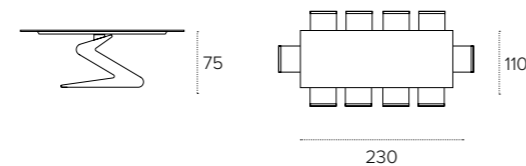

COD. TP204 - TOP A BOTTICELLA 200X100 cm

L 200 P 100 H 75 cm

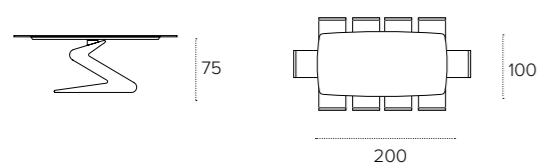

COD. TP205 - TOP RETTANGOLARE 200/300X100 CM

L 200 P 100 H 75 cm

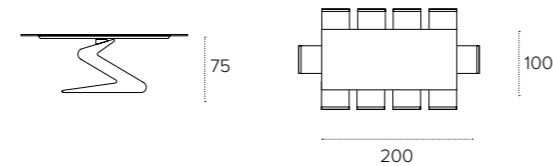

ECLIPSE

TAVOLO ALLUNGABILE / EXTENDABLE TABLE
COD. TA402 - TOP 180/270X90 cm

Tavolo allungabile con basamento in poliuretano Terra 8239 e piano in gres porcellanato effetto marmo Emperador 3660.

Extendable table with Earth 8239 polyurethane base and Emperador 3660 marble-effect porcelain stoneware top.

Table extensible avec piétement central en polyuréthane Terre 8239 et plateau en céramique effet marbre Emperador 3660.

Mesa extensible con base central en poliuretano Tierra 8239 y encimera en porcelánico efecto marmol Emperador 3660.

Sedia/Chair/Chaise/Silla SEATTLE SE618.



ECLIPSE

TAVOLO ALLUNGABILE / EXTENDABLE TABLE
COD. TA402 - TOP 180/270X90 cm

Tavolo allungabile con basamento in poliuretano Nero 8210 e piano in gres porcellanato effetto marmo Calacatta 3808.

Extendable table with Black 8210 polyurethane base and Calacatta 3808 marble-effect porcelain stoneware top.

Table extensible avec piètement central en polyuréthane Noir 8210 et plateau en céramique effet marbre Calacatta 3808.

Mesa extensible con base central en poliuretano Negro 8210 y encimera en porcelánico efecto marmol Calacatta 3808.

Sedia/Chair/Chaise/Silla MALAGA NEW SE1B0.

FINITURE / Finishes

STRUTTURA / Frame
 poliuretano / polyurethane



8208
Bianco
White



8212
Bronzo
Bronze



8221
Grafite
Graphite



8239
Terra
Earth



8210
Nero
Black



8204
Oro
Gold

PIANO / Top
 gres opaco /
 matt stoneware



3521
Grafite
Graphite



3808
Calacatta
Calacatta

PIANO / Top
 gres lucido /
 glossy stoneware



3828
Carrara
Carrara



3816
Alabastro
Alabaster



3818
Arabescato
Arabesque



3660
Emperador
Emperador

MISURE / Size

L 180/270 P 90 H 75 cm

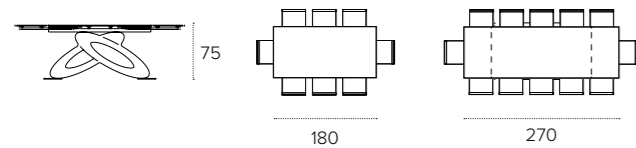

ECLIPSE

TAVOLO FISSO / NON-EXTENDABLE TABLE
COD. TP402 - TOP 180X90 cm

Tavolo fisso con basamento in poliuretano Bianco 8208 e piano in gres porcellanato effetto marmo Carrara 3828.

Non-extendable table with White 8208 polyurethan basement and Cararra 3828 marble-effect porcelain stoneware top.

Table fixe avec piètement central en polyuréthane Blanc 8208 et plateau en céramique effet marbre Cararre 3828.

Mesa fija con base central en poliuretano Banco 8208 y encimera en porcelánico efecto marmol Carrara 3828.

Sedia/Chair/Chaise/Silla BILBAO SE194.

FINITURE / Finishes

STRUTTURA / Frame
 poliuretano / polyurethane



8208
Bianco
White



8212
Bronzo
Bronze



8221
Grafite
Graphite



8239
Terra
Earth



8210
Nero
Black



8204
Oro
Gold

PIANO / Top
 gres opaco /
 matt stoneware



3521
Grafite
Graphite



3808
Calacatta
Calacatta

PIANO / Top
 gres lucido /
 glossy stoneware



3828
Carrara
Carrara



3816
Alabastro
Alabaster



3818
Arabescato
Arabesque



3660
Emperador
Emperador

MISURE / Size

COD. TP402 - TOP RETTANGOLARE 180X90 CM

L 180 P 90 H 75 cm

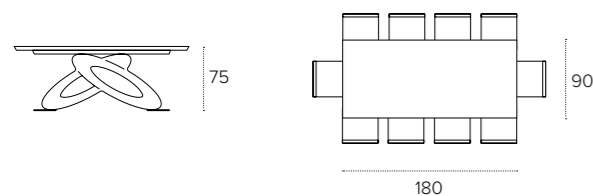

FINITURE / Finishes

STRUTTURA / Frame
 poliuretano / polyurethane



8208
Bianco
White



8212
Bronzo
Bronze



8221
Grafite
Graphite



8239
Terra
Earth



8210
Nero
Black



8204
Oro
Gold

PIANO / Top
 gres lucido /
 glossy stoneware



3828
Carrara
Carrara

MISURE / Size

COD. TP405 - TOP A BOTTICELLA 230X110 CM

L 230 P 110 H 75 cm

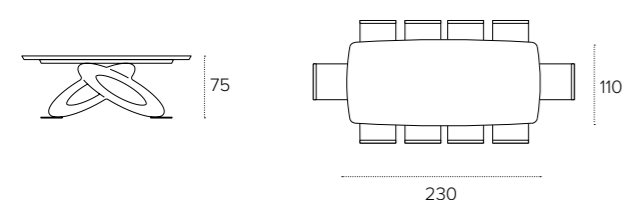

ECLIPSE

TAVOLO ALLUNGABILE / EXTENDABLE TABLE
COD. TA400 - TOP 200/300X100 cm

Tavolo allungabile con basamento in poliuretano Oro 8204, struttura in alluminio e piano in vetro temperato Trasparente 2001.

Extendable table with Gold 8204 polyurethan central basement, aluminium frame, and Transparent 2001 tempered glass top.

Table extensible avec piétement central Or 8204, coulisse en aluminium et plateau en verre trempé Transparent 2001.

Mesa extensible con base central en poliuretano Oro 8204, bastidor en aluminio y encimera en cristal templado Transparente 2001.

Sedia/Chair/Chaise/Silla BRASILIA SE1A0.



ECLIPSE

TAVOLO FISSO / NON-EXTENDABLE TABLE
COD. TP400 - TOP 220X100 cm

Tavolo fisso con basamento in poliuretano Bronzo 8212 e piano ovale in vetro temperato Trasparente 2001.
Non-extendable table with Bronze 8212 polyurethan basement and Transparent 2001 tempered glass top.
Table fixe avec piètement central en polyuréthane Bronze 8212 et plateau ovale en verre trempé Transparent 2001.
Mesa fija con base central en poliuretano Bronce 8212 y encimera oval en cristal templado Transparente 2001.

Sedia/Chair/Chaise/Silla PORTLAND SE620.



ECLIPSE

TAVOLO FISSO / NON-EXTENDABLE TABLE
COD. TA400 - TOP 200/300X100 cm

Tavolo allungabile con basamento in poliuretano Grafite 8221 e piano in vetro temperato Trasparente 2001.
 Extendable table with Graphite 8221 polyurethane basement and Transparent 2001 tempered glass top.
 Table extensible avec piètement central en polyuréthane Graphite 8221 et plateau en verre trempé Transparent 2001.
 Mesa extensible con base central en poliuretano Grafito 8221 y encimera en cristal templado Transparente 2001.



FINITURE / Finishes

STRUTTURA / Frame
 poliuretano / polyurethane



8208
Bianco
White



8212
Bronzo
Bronze



8221
Grafite
Graphite



8239
Terra
Earth



8210
Nero
Black



8204
Oro
Gold

PIANO / Top
 gres / stoneware



2001
Trasparente
Transparent

MISURE / Size **COD. TA400**

L 200 / 300 P 100 H 75 cm

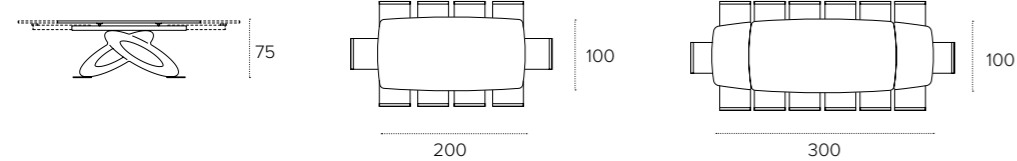

MISURE / Size **COD. TP400**

L 220 P 115 H 76 cm

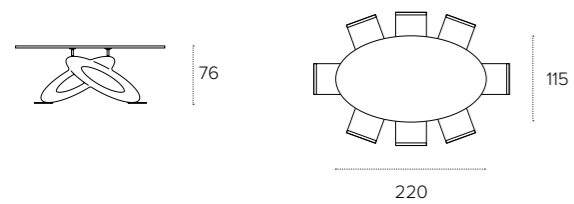

ECLIPSE

TAVOLO FISSO / NON-EXTENDABLE TABLE
COD. TP405 - TOP 230X110 cm

Tavolo fisso con basamento in poliuretano Bianco 8208 e piano a botticella impiallacciato legno Tabacco 1071.
Non-extendable table with White 8208 polyurethane basement and Tobacco 1071 wood veneered top.
Table fixe avec piètement en polyuréthane Blanc 8208 et plateau en placage bois Tabac 1071.
Mesa fija con base central en poliuretano Blanco 8208 y encimera en chapa de madera Tabaco 1071.

Sedie/chairs/chaises/sillas GINEVRA SE515.













ECLIPSE

TAVOLO FISSO / NON-EXTENDABLE TABLE
COD. TP405 - TOP 230X110 cm

Tavolo fisso con basamento in poliuretano Bianco 8208 e piano a botticella impiallacciato legno Tabacco 1071.
 Non-extendable table with White 8208 polyurethane basement and Tobacco 1071 wood veneered top.
 Table fixe avec piètement en polyuréthane Blanc 8208 et plateau en placage bois Tabac 1071.
 Mesa fija con base central en poliuretano Blanco 8208 y encimera en chapa de madera Tabaco 1071.

Sedie/chairs/chaïses/sillas GINEVRA SE515.

FINITURE / Finishes

STRUTTURA / Frame poliuretano/polyurethane	 8208 Bianco White	 8212 Bronzo Bronze	 8221 Grafite Graphite	 8239 Terra Earth	 8204 Oro Gold	 8210 Nero Black
PIANO / Top legno / wood	 1012 Noce Walnut	 1020 Piombo Lead	 1027 Rustico Country	 1071 Tabacco Tobacco		
PIANO / Top gres lucido / glossy stoneware	 3828 Carrara Carrara	*disponibile solamente per TP405 / only available for TP405				

MISURE / Size

ECLIPSE 200 RETTANGOLARE COD. TP403

L 200 P 100 H 75 cm

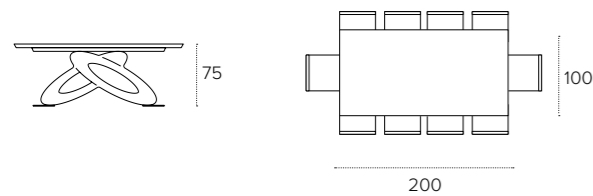

ECLIPSE 200 BOTTICELLA COD. TP404

L 200 P 100 H 75 cm

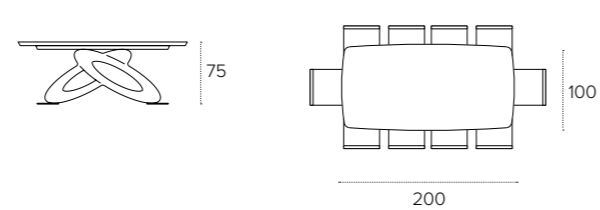

ECLIPSE 230 RETTANGOLARE COD. TP407

L 230 P 100 H 75 cm

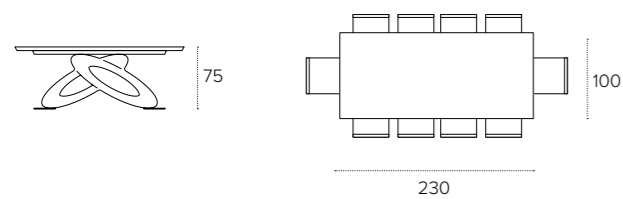

ECLIPSE 230 BOTTICELLA COD. TP405

L 230 P 110 H 75 cm

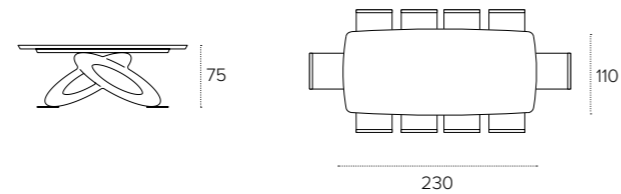

CRYSTAL PLUS

TAVOLO ALLUNGABILE / EXTENDABLE TABLE
COD. TAC01 - TOP 200/300X100 cm

Tavolo allungabile con struttura in alluminio, gambe in vetro curvato e piano in vetro temperato Trasparente 2001.
Extendable table with aluminium frame, curved glass legs and Transparent 2001 tempered glass top.
Table extensible avec coulisses en aluminium, pieds en verre plié et plateau en verre trempé Transparent 2001.
Mesa extensible con bastidor en aluminio, patas en cristal curvado y encimera en cristal templado Transparente 2001.

Sedia/Chair/Chaise/Silla FUTURA SE800.



CRYSTAL PLUS

TAVOLO ALLUNGABILE / EXTENDABLE TABLE

COD. TAC01 - TOP 200/300X100 cm

Tavolo allungabile con struttura in alluminio, gambe in vetro curvato e piano in vetro temperato Trasparente 2001.

Extendable table with aluminium frame, curved glass legs and Transparent 2001 tempered glass top.

Table extensible avec coulisses en aluminium, pieds en verre plié et plateau en verre trempé Transparent 2001.

Mesa extensible con bastidor en aluminio, patas en cristal curvado y encimera en cristal templado Transparente 2001.

FINITURE / Finishes

STRUTTURA / Frame
vetro temperato /
tempered glass



2001
Trasparente
Transparent

PIANO / Top
vetro temperato /
tempered glass



2001
Trasparente
Transparent

MISURE / Size

L 200 / 300 P 100 H 76 cm

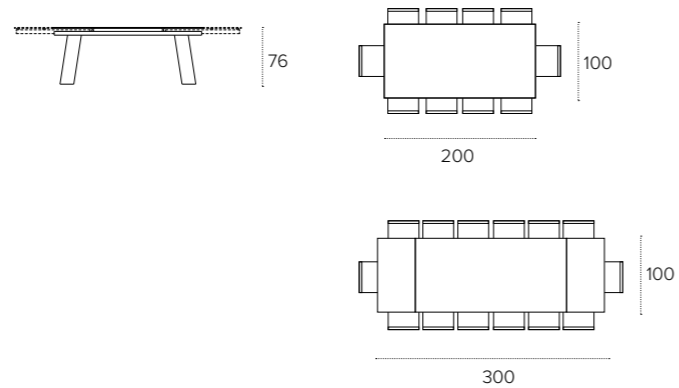

COSMOS

TAVOLO FISSO / NON-EXTENDABLE TABLE
COD. TP1E2 - TOP 180X90 cm

Tavolo fisso con basamento in metallo Bronzo 0112 e piano a botticella in gres porcellanato effetto marmo Emperador 3660.

Non-extendable table with Bronze 0112 metal base and barrel-shaped top made in Emperador 3660 porcelain gres stoneware.

Table fixe avec piètement en métal peint Bronze 0112 et plateau en formede tonneau en céramique effet marbre Emperador 3660.

Mesa fija con base en metal Bronce 0112 y encimera ovalada en porcelanico efecto marmol Emperador 3660.

Sedia/Chair/Chaise/Silla MALAGA SE195.



COSMOS

TAVOLO ALLUNGABILE / EXTENDABLE TABLE
COD. TA1E2 - TOP 160/240X90 cm

Tavolo allungabile con basamento in metallo Bronzo 0112 e piano girevole a botticella in gres porcellanato effetto marmo Alabastro 3816.

Extendable table with Bronze 0112 metal base and rotating barrel-shaped top made in Alabaster 3816 marble-effect porcelain gres stoneware.

Table extensible avec piétement en métal peint Bronze 0112 et plateau pivotant en forme de tonneau en céramique effet marbre Albatre 3816.

Mesa extensible con base en metal pintado Bronce 0112 y encimera giratoria ovalada en porcelanico efecto marmol Alabastro 3816.

Sedia/Chair/Chaise/Silla GRANADA SE1A2.
Madia/Sideboard/Bufet/Apardor GIUNONE MA112



COSMOS

TAVOLO ALLUNGABILE / EXTENDABLE TABLE
COD. TA1E2 - TOP 160/240X90 cm

Tavolo allungabile con basamento in metallo Grafite 0122 e piano girevole a botticella in gres porcellanato effetto marmo Fiordibosco 3822.

Extendable table with Graphite 0122 metal base and rotating barrel-shaped top made in Fiordibosco 3822 porcelain gres stoneware.

Table extensible avec piétement en métal peint Graphite 0122 et plateau pivotant en forme de tonneau en céramique effet marbre Fiordibosco 3822.

Mesa extensible con base en metal pintado Grafito 0122 y encimera giratoria ovalada en porcelánico efecto marmol Fiordibosco 3822.

Sedia/Chair/Chaise/Silla BILBAO SE194.



COSMOS

TAVOLO ALLUNGABILE / EXTENDABLE TABLE
COD. TA1E2 - TOP 160/240X90 cm

Tavolo allungabile con basamento in metallo Grafite 0122 e piano girevole a botticella in gres porcellanato effetto marmo Fiordibosco 3822.

Extendable table with Graphite 0122 metal base and rotating barrel-shaped top made in Fiordibosco 3822 porcelain gres stoneware.

Table extensible avec piètement en métal peint Graphite 0122 et plateau pivotant en forme de tonneau en céramique effet marbre Fiordibosco 3822.

Mesa extensible con base en metal pintado Grafito 0122 y encimera giratoria ovalada en porcelanico efecto marmol Fiordibosco 3822.

FINITURE / Finishes

STRUTTURA / Frame
 metallo / metal



PIANO / Top
 gres opaco /
 matt stoneware

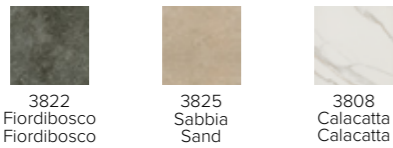

PIANO / Top
 gres lucido /
 glossy stoneware

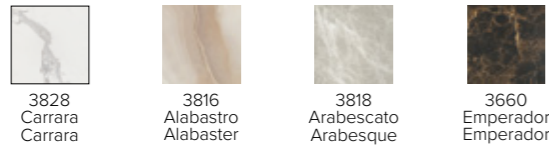

MISURE / Size

COD. TA1E2 BOTTICELLA GIREVOLE
 L 160/240 P 90 H 78 CM

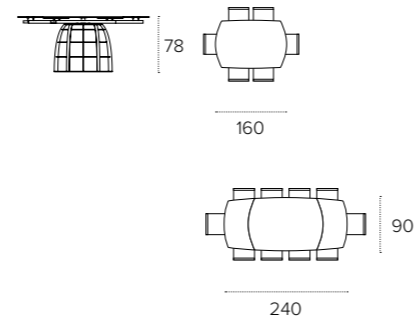

TOP GIREVOLE

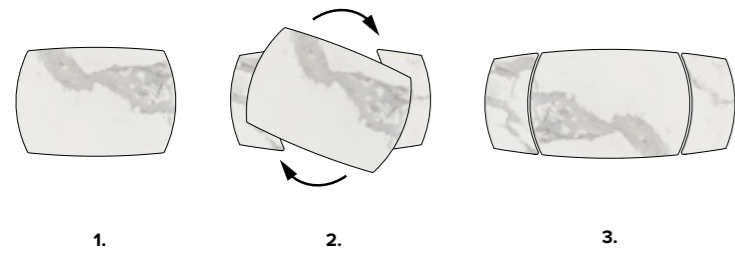

SCOPRI IL NOSTRO PIANO GIREVOLE!
 DISCOVER OUR ROTATING TOP!
 DÉCOUVREZ NOTRE PLATEAU PIVOTANT!
 DESCUBRE NUESTRA ENCIMERA GIRATORIA!

FINITURE / Finishes

STRUTTURA / Frame
 metallo / metal



PIANO / Top
 gres opaco /
 matt stoneware



PIANO / Top
 gres lucido /
 glossy stoneware



MISURE / Size

COD. TP1E2 BOTTICELLA
 L 180 P 90 H 75 cm

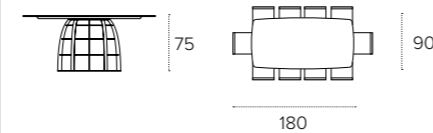

PRIAMO

TAVOLO ALLUNGABILE / EXTENDABLE TABLE
COD. TA1A1 - 180/270X90 cm

Tavolo allungabile con basamento centrale in metallo
Spazzolato argento 0640 e piano in gres porcellanato
effetto marmo Arabescato 3818.

Extendable table with Brushed silver 0640 metal central
basement and Arabesque 3818 marble-effect porcelain
stoneware top.

Table extensible avec piètement central en métal Brossé
argent 0640 et plateau en céramique effet marbre
Arabesque 3818.

Mesa extensible con base central en metal Cepillado plata
0640 y encimera en porcelanico efecto marmol Arabescato
3818.

Sedia/Chair/Chaise/Silla BELLINZONA SE507.



PRIAMO

TAVOLO ALLUNGABILE / EXTENDABLE TABLE
COD. TA1A1 - 180/270X90 cm

Tavolo allungabile con basamento centrale in metallo Bianco 0108 e piano in gres porcellanato effetto marmo Alabastro 3816.

Extendable table with White 0108 metal central basement and Alabaster 3816 marble-effect porcelain stoneware top.
Table extensible avec piètement central en métal Blanc 0108 et plateau en céramique effet marbre Albatre 3816.
Mesa extensible con base central en metal Blanco 0108 y encimera en porcelánico efecto marmol Alabastro 3816.

Sedia/Chair/Chaise/Silla ZURIGO SE503.



PRIAMO

TAVOLO ALLUNGABILE / EXTENDABLE TABLE
COD. TA1B1 - 160/240X90 cm

Tavolo allungabile con struttura in metallo verniciato Bianco 0108. Piano ed allunghe laterali in gres porcellanato effetto marmo Carrara 3828.

Extendable table with White 0108 painted metal frame. Top and side extensions in Carrara 3828 marble-effect porcelain gres stoneware.

Table extensible avec pied central et coulisses en fer peint Blanc 0108. Plateau et allonges latérales en céramique effet marbre Carrara 3828.







Mesa extensible con pata y bastidor en metal pintado Blanco 0108. Encimera y extensibles laterales en gres porcelánico efecto marmol Carrara 3608.

Sedia/Chair/Chaise/Silla DIGIONE SE185.



PRIAMO

FINITURE / Finishes

STRUTTURA / Frame metallo/metal	 0108 Bianco White	 0112 Bronzo Bronze	 0122 Grafite Graphite	 0139 Terra Earth	 0640 Spazzolato Argento Silver Brushed	 0110 Nero Black
---------------------------------	--	---	--	---	---	--

PIANO / Top gres lucido / glossy stoneware	 3808 Carrara Carrara	 3816 Alabastro Alabaster	 3818 Arabescato Arabesque	 3660 Emperador Emperador	PIANO / Top gres opaco / matt stoneware	 3808 Calacatta Calacatta
--	---	---	--	---	---	---

MISURE / Size

PRIAMO 180 ALLUNGABILE COD. TA1A1

L 180 / 270 P 90 H 75 cm

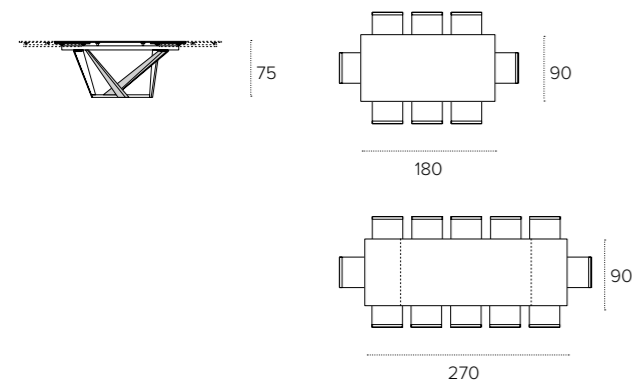





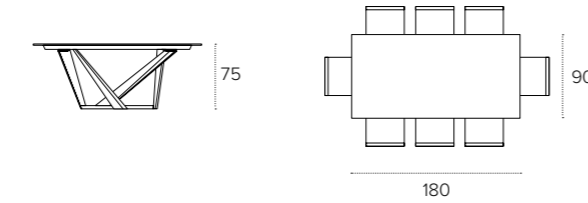





PRIAMO 180 FISSO COD. TP1A1

L 180 P 90 H 75 cm



FINITURE / Finishes

STRUTTURA / Frame metallo / metal	 0108 Bianco White	 0112 Bronzo Bronze	 0122 Grafite Graphite	 0139 Terra Earth	 0640 Spazzolato Argento Silver Brushed	 0110 Nero Black
-----------------------------------	--	---	--	---	---	--

PIANO / Top gres opaco / matt stoneware	 3521 Grafite Graphite	 3822 Fiordibosco Fiordibosco	 3825 Sabbia Sand	 3808 Calacatta Calacatta
---	--	---	---	---

PIANO / Top gres lucido / glossy stoneware	 3808 Carrara Carrara	 3816 Alabastro Alabaster	 3818 Arabescato Arabesque	 3660 Emperador Emperador
--	---	---	--	---

MISURE / Size

PRIAMO 160 ALLUNGABILE COD. TA1B1

L 160/240 P 90 H 75 cm

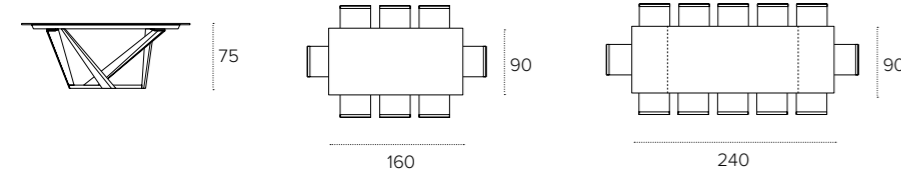

TAVOLO ALLUNGABILE / EXTENDABLE TABLE COD. TA1B1

Tavolo allungabile con struttura in metallo verniciato Grafite. Piano ed allunghe laterali in gres porcellanato Grafite 3521.
Extendable table with Graphite 0122 painted metal frame. Top and side extensions in Graphite 3521 porcelain stoneware.
Table extensible avec pied central et coulisses en métal peint Graphite 0122. Plateau et allonges latérale en céramique Graphite 3521.
Mesa extensible con pata y bastidor en metal pintado Grafite 0122 y encimera y extensibles laterales en gres porcelánico Grafite 3521.

Sedie/Chairs/Chaises/Sillas BILBAO SE194.



PRIAMO

TAVOLO FISSO / NON-EXTENDABLE TABLE
COD. TP162 - 230X110 CM

Tavolo fisso con basamento in metallo verniciato Bianco 0108 e piano a botticella in gres porcellanato effetto marmo Carrara 3828.

Non-extendable table with White 0108 painted metal basement and barrel shaped top in Carrara 3828 marble-effect porcelain gres.

Table fixe avec piètement en fer peint Blanc 0108 et plateau en forme de tonneau en céramique effet marbre Carrare 3828.

Mesa fija con base central en metal pintado Blanco 0108 y encimera en forma de barril en porcelanico efecto marmol Carrara 3828.

Sedia/chair/chaise/silla BILBAO SE194.

Madia/sideboard/buffet/aparador GIUNONE MA112.



FINITURE / Finishes

STRUTTURA / Frame
metallo/metal



0108
Bianco
White



0112
Bronzo
Bronze



0122
Grafite
Graphite



0139
Terra
Earth



0640
Spazzolato Argento
Silver Brushed



0110
Nero
Black

PIANO / Top
gres lucido /
glossy stoneware



3808
Carrara
Carrara

MISURE / Size

L 230 P 110 H 75 cm

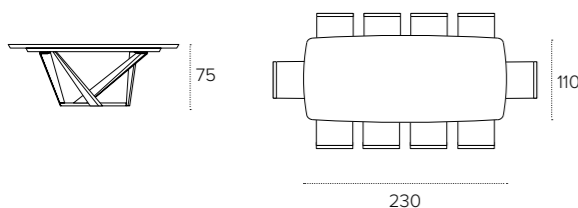

PRIAMO

TAVOLO FISSO / NON-EXTENDABLE TABLE
COD. TP162 - 230X110 cm

Tavolo fisso con basamento in metallo verniciato Terra 0139 e piano impiallacciato legno Tabacco 1071.
Non-extendable table with Earth 0139 painted metal base-ment and Tobacco 1071 wood veneered top.
Table fixe avec piètement en fer peint Terre 0139 et plateau en placage bois Tabac 1071.
Mesa fija con base central en metal pintado Tierra 0139 y encimera en chapa de madera Tabaco 1071.

Sedia/chair/chaise/silla VIENNA SE608.



PRIAMO

TAVOLO FISSO / NON-EXTENDABLE TABLE
COD. TP157 - TOP 200X100 cm

Tavolo fisso con struttura in metallo verniciato Grafite 0122 e piano rettangolare impiallacciato legno Piombo 1020.

Non-extendable table with Graphite 0122 painted metal frame and Lead 1020 wood veneer top.

Table fixe avec structure en fer peint Graphite 0122 et plateau en placage bois Plomb 1021.

Mesa fija con estructura en metal pintado Grafito 0122 y encimera en chapa de madera Plomo 1021.

Sedie/chairs/chaises/sillas BELLINZONA SE507.

FINITURE / Finishes

STRUTTURA / Frame
 metallo / metal



0108
Bianco
White



0112
Bronzo
Bronze



0122
Grafite
Graphite



0139
Terra
Earth



0640
Spazzolato Argento
Silver Brushed



0110
Nero
Black

PIANO / Top
 legno / wood



1012
Noce
Walnut



1020
Piombo
Lead



1027
Rustico
Country



1071
Tabacco
Tobacco

MISURE / Size

PRIAMO 200 RETTANGOLARE COD. TP157

L 200 P 100 H 75 cm

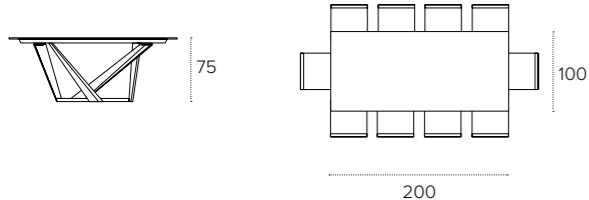

PRIAMO 200 BOTTICELLA COD. TP158

L 200 P 100 H 75 cm

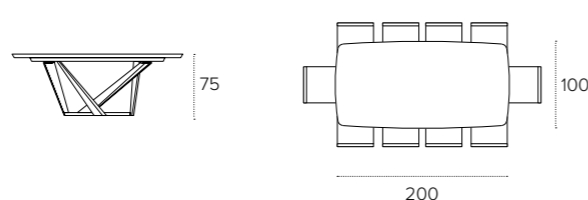

PRIAMO 230 RETTANGOLARE COD. TP165

L 230 P 100 H 75 cm

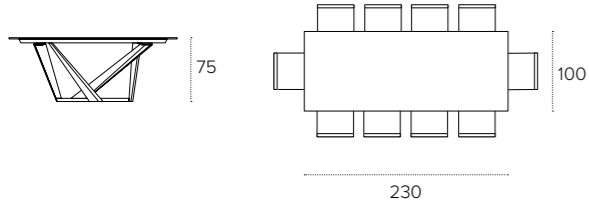

PRIAMO 230 BOTTICELLA COD. TP162

L 230 P 110 H 75 cm

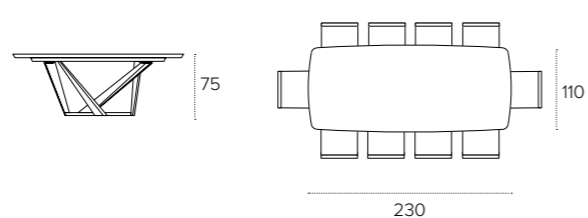

TAURUS

TAVOLO ALLUNGABILE / EXTENDABLE TABLE
COD. TA1A0 - TOP 180/270X90 cm

Tavolo allungabile con basamento centrale in metallo
Spazzolato argento 0640 e piano in gres porcellanato
effetto marmo Arabescato 3818.

Extendable table with Brushed silver 0640 metal central
basement and Arabesque 3818 marble-effect porcelain
stoneware top.

Table extensible avec piétement central en métal Brossé
argent 0640 et plateau en céramique effet marbre
Arabesque 3818.

Mesa extensible con base central en metal Cepillado plata
0640 y encimera en porcelánico efecto marmol Arabescato
3818.

Sedia/Chair/Chaise/Silla VIENNA SE608.



TAURUS

TAVOLO ALLUNGABILE / EXTENDABLE TABLE
COD. TA1A2 - TOP 180/270X90 cm

Tavolo allungabile con basamento centrale in metallo Nero 0110 e piano in gres porcellanato effetto marmo Calacatta 3808.

Extendable table with Black 0110 metal central basement and Calacatta 3808 marble-effect porcelain stoneware top.

Table extensible avec piètement central en métal Noir 0110 et plateau en céramique effet marbre Calacatta 3808.

Mesa extensible con base central en metal Negro 0110 y encimera en porcelánico efecto marmol Calacatta 3808.

Sedia/Chair/Chaise/Silla ZURIGO SE503.



TAURUS

TAVOLO ALLUNGABILE / EXTENDABLE TABLE
COD. TA1A2 - TOP 180/270X90 cm

Tavolo allungabile con struttura in metallo verniciato Terra 0139, piano ed allunghe laterali in gres porcellanato effetto marmo Emperador 3660.

Extendable table with Earth 0139 painted metal structure, top and side extensions in Emperador 3660 marble-effect porcelain gres stoneware.

Table extensible avec piétement central en fer peint Terre 0139, plateau et allonges latérales en céramique effet marbre Emperador 3660.

Mesa extensible con pata central y bastidor en metal pintado Tierra 0139, encimera y extensibles laterales en porcelánico efecto marmol Emperador 3660.

Sedia/chair/chaise/silla SALISBURGO SE508.



TAURUS

TAVOLO ALLUNGABILE / EXTENDABLE TABLE

COD. TA1A2 - TOP 180/270X90 cm

Tavolo allungabile con struttura in metallo verniciato Terra 0139, piano ed allunghe laterali in gres porcellanato effetto marmo Emperador 3660.

Extendable table with Earth 0139 painted metal structure, top and side extensions in Emperador 3660 marble-effect porcelain gres stoneware.

Table extensible avec piétement central en fer peint Terre 0139, plateau et allonges latérales en céramique effet marbre Emperador 3660.

Mesa extensible con pata central y bastidor en metal pintado Tierra 0139, encimera y extensibles laterales en porcelánico efecto marmol Emperador 3660.

FINITURE / Finishes

STRUTTURA / Frame
metallo / metal



0108
Bianco
White



0112
Bronzo
Bronze



0122
Grafite
Graphite



0139
Terra
Earth



0640
Spazzolato Argento
Silver Brushed



0110
Nero
Black

PIANO / Top
gres opaco /
matt stoneware



3521
Grafite
Graphite



3808
Calacatta
Calacatta

PIANO / Top
gres lucido /
glossy stoneware



3828
Carrara
Carrara



3816
Alabastro
Alabaster



3818
Arabescato
Arabesque



3660
Emperador
Emperador

MISURE / Size

TAURUS 180 ALLUNGABILE COD. TA1A2

L 180 / 270 P 90 H 75 cm

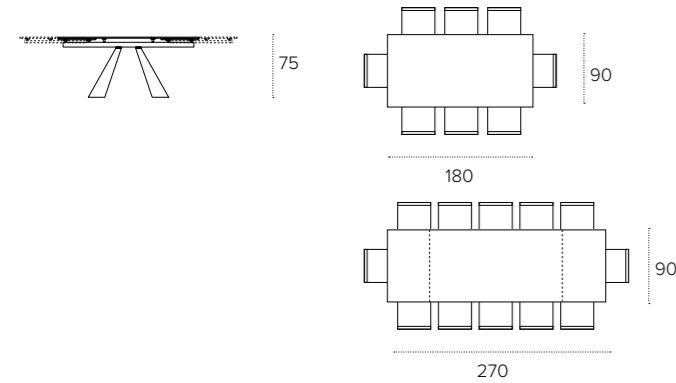

TAURUS 180 FISSO COD. TP1A2

L 180 P 90 H 75 cm gres/gres

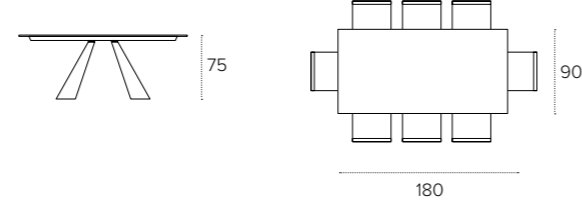

FINITURE / Finishes

STRUTTURA / Frame
metallo / metal



0108
Bianco
White



0112
Bronzo
Bronze



0122
Grafite
Graphite



0139
Terra
Earth



0640
Spazzolato Argento
Silver Brushed



0110
Nero
Black

PIANO / Top
gres opaco /
matt stoneware



3822
Fiordibosco
Fiordibosco



3825
Sabbia
Sand



3808
Calacatta
Calacatta

PIANO / Top
gres lucido /
glossy stoneware



3828
Carrara
Carrara



3816
Alabastro
Alabaster



3818
Arabescato
Arabesque



3660
Emperador
Emperador

MISURE / Size

TAURUS 160 ALLUNGABILE COD. TA1E0

L 160 / 240 P 90 H 75 cm

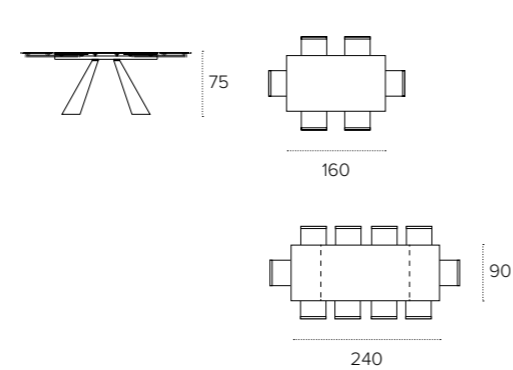

TAURUS

TAVOLO FISSO / NON-EXTENDABLE TABLE
COD. TP163 - 230X110 cm

Tavolo fisso con basamento in metallo verniciato Bianco 0108 e piano in gres porcellanato effetto marmo Carrara 3828.
Non-extendable table with White 0108 painted metal basement and Carrara 3828 marble-effect porcelain gres top.
Table fixe avec piètement en fer peint Blanc 0108 et plateau en céramique effet marbre Carrare 3828.
Mesa fija con base central en metal pintado Blanco 0108 y encimera en porcelanico efecto marmol Carrara 3828.

Sedia/chair/chaise/silla VIENNA SE608.



FINITURE / Finishes

STRUTTURA / Frame
metallo / metal



0108
Bianco
White



0112
Bronzo
Bronze



0122
Grafite
Graphite



0139
Terra
Earth



0640
Spazzolato Argento
Silver Brushed



0110
Nero
Black

PIANO / Top
gres lucido /
glossy stoneware



3828
Carrara
Carrara

MISURE / Size

L 200 P 100 H 75 cm

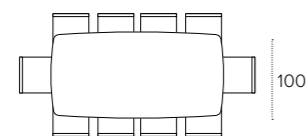
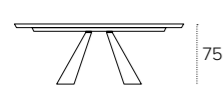

200

TAURUS

TAVOLO FISSO / NON-EXTENDABLE TABLE
COD. TP161 - TOP 200X100 cm

Tavolo fisso con struttura in metallo verniciato Grafite 0122. Piano a botticella impiallacciato con legno Rovere Rustico 1027.

Non-extendable table with Graphite 0122 painted metal frame and leg, top made in Country Oak 1027 barrel-shaped veneered wood.

Table fixe avec pied central et coulisses en métal peint Graphite 0122 et plateau en forme de tonneau en bois plaqué chêne Rustique 1027.

Mesa fija con pata y bastidor en metal pintado Grafito 0122 y encimera en forma de barril en chapa de madera roble Rustico 1027.

Sedie/Chairs/Chaises/Sillas BELLINZONA SE507.



TAURUS

TAVOLO FISSO / NON-EXTENDABLE TABLE
COD. TP161 - TOP 200X100 cm

Tavolo fisso con struttura in metallo verniciato Grafite 0122. Piano a botticella impiallacciato con legno Rovere Rustico 1027.

Non-extendable table with Graphite 0122 painted metal frame and leg, top made in Country Oak 1027 barrel-shaped veneered wood.

Table fixe avec pied central et coulisses en métal peint Graphite 0122 et plateau en forme de tonneau en bois plaqué chêne Rustique 1027.

Mesa fija con pata y bastidor en metal pintado Grafito 0122 y encimera en forma de barril en chapa de madera roble Rustico 1027.

Sedie/Chairs/Chaises/Sillas BELLINZONA SE507.

FINITURE / Finishes

STRUTTURA / Frame
 metallo / metal



0108
Bianco
White



0112
Bronzo
Bronze



0122
Grafite
Graphite



0139
Terra
Earth



0640
Spazzolato Argento
Silver Brushed



0110
Nero
Black

PIANO / Top
 legno / wood



1012
Noce
Walnut



1020
Piombo
Lead



1027
Rustico
Country



1071
Tabacco
Tobacco

MISURE / Size

TAURUS 200 RETTANGOLARE COD. TP160

L 200 P 100 H 75 cm

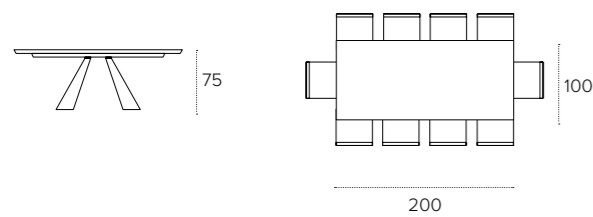

TAURUS 200 BOTTICELLA COD. TP161

L 200 P 100 H 75 cm

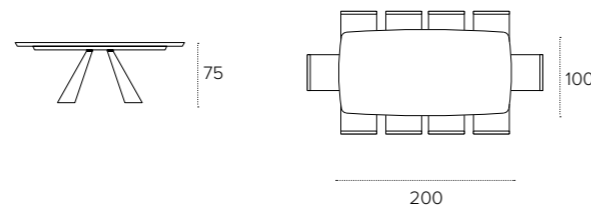

TAURUS 230 RETTANGOLARE TP COD. TP167

L 230 P 100 H 75 cm

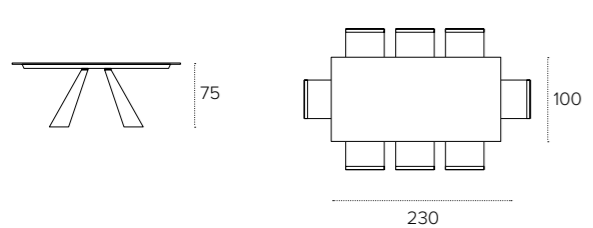

TAURUS 230 A BOTTICELLA TP COD. TP163

L 230 P 100 H 75 cm

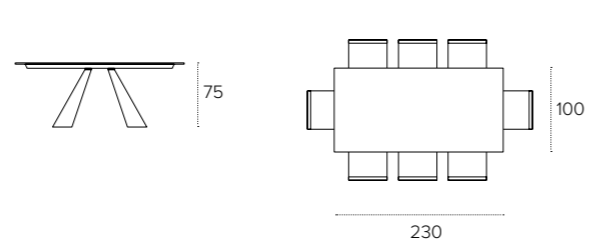

DELTA

TAVOLO ALLUNGABILE / EXTENDABLE TABLE
COD. TA519 - TOP 180/270X90 cm

Tavolo allungabile con struttura in laminato effetto metallo Bronzo 1F02. Piano ed allunghe laterali in gres porcellanato effetto marmo Emperador 3660.
Extendable table with structure in Bronze 1F02 metal-effect laminate. Top and side extensions in Emperador 3660 marble-effect porcelain gres stoneware.
Table extensible avec structure en stratifié effet métal Bronze 1F02. Plateau et allonges latérales en céramique effet marbre Emperador 3660.
Mesa extensible con estructura en laminado efecto metal Bronce 1F02. Encimera y extensibles laterales en porcelánico efecto marmol Emperador 3660.

Sedia / Chair / Chaise / Silla MALAGA NEW SE1B0.



DELTA

TAVOLO ALLUNGABILE / EXTENDABLE TABLE
COD. TA519 - TOP 180/270X90 cm

Tavolo allungabile con struttura in laminato effetto metallo Argento 1F40. Piano ed allunghe laterali in gres porcellanato effetto marmo Arabescato 3818.

Extendable table with Silver 1F40 metal-effect laminate structure. Top and side extensions in Arabesque 3818 marble-effect porcelain gres stoneware.

Table extensible avec structure en stratifié effet métal Argent 1F40. Plateau et allonges latérales en céramique effet marbre Arabesque 3818.

Mesa extensible con estructura en laminado efecto metal Plata 1F40. Encimera y extensibles laterales en porcelánico efecto marmol Arabescato 3818.

Sedia / Chair / Chaise / Silla SEATTLE SE618
Madia / Sideboard / Buffet / Aparador GIUNONE MA112











DELTA

TAVOLO ALLUNGABILE / EXTENDABLE TABLE
COD. TA519 - TOP 180/270X90 cm

Dettaglio piano in gres porcellanato effetto marmo Arabescato 3818.
 Detail of top in Arabesque 3818 marble-effect porcelain gres stoneware.
 Détail du plateau en céramique effet marbre Arabesque 3818.
 Detalle encimera en porcelánico efecto marmol Arabescato 3818.







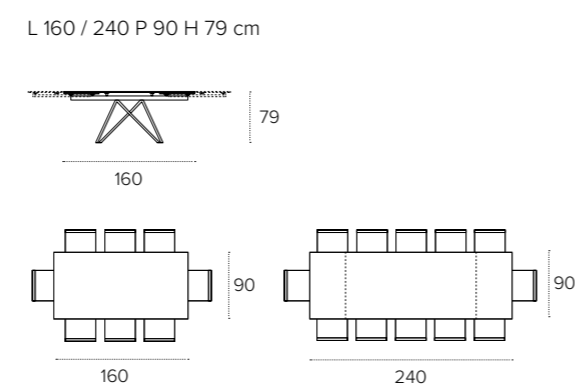

FINITURE / Finishes

STRUTTURA / Frame laminato effetto metallo / metal-effect laminate				laminato effetto legno wood-effect laminate	
	1F02 Bronzo Bronze	1F22 Piombo Lead	1F40 Argento Silver		1728 Rustico Bianco White Country
PIANO / Top gres lucido / glossy stoneware					
	3828 Carrara Carrara	3816 Alabastro Alabaster	3818 Arabescato Arabesque	3660 Emperador Emperador	
PIANO / Top gres opaco / matt stoneware					
	3808 Calacatta Calacatta				

MISURE / Size **COD. TA523**



FINITURE / Finishes

STRUTTURA / Frame laminato effetto metallo / metal-effect laminate				laminato effetto legno wood-effect laminate	
	1F02 Bronzo Bronze	1F22 Piombo Lead	1F40 Argento Silver		1728 Rustico Bianco White Country
PIANO / Top gres lucido / glossy stoneware					
	3828 Carrara Carrara	3816 Alabastro Alabaster	3818 Arabescato Arabesque	3660 Emperador Emperador	
PIANO / Top gres opaco / matt stoneware					
	3808 Calacatta Calacatta				

MISURE / Size **COD. TA519**

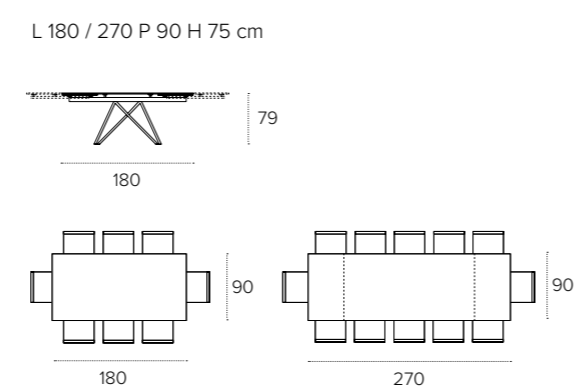

TRITONE

TAVOLO ALLUNGABILE / EXTENDABLE TABLE
COD. TA516 - TOP 160/240X90 cm

Tavolo allungabile con struttura in laminato effetto metallo Piombo 1F22 e Argento 1F40. Piano ed allunghe laterali in gres porcellanato effetto marmo Fiordibosco 3822.
Extendable table with structure in Lead 1F22 and Silver 1F40 metal-effect laminate. Top and side extensions in Fiordibosco 3822 marble-effect porcelain stoneware.
Table extensible avec structure en stratifié effet métal Plomb 1F22 et Argent 1F40. Plateau et allonges en céramique effet marbre Fiordibosco 3822.
Mesa extensible con estructura en laminado efecto metal Plomo 1F22 y Plata 1F40. Encimera y extensibles en porcelánico efecto marmol Fiordibosco 3822.

Sedia / Chair / Chaise / Silla DALLAS SE616.



TRITONE

TAVOLO ALLUNGABILE / EXTENDABLE TABLE
COD. TA516 - TOP 160/240X90 cm

Tavolo allungabile con struttura in laminato effetto metallo Bronzo 1F02 e Rustico 1727. Piano ed allonghe laterali in gres porcellanato effetto marmo Sabbia 3825.

Extendable table with structure in Bronze 1F02 metal-effect laminate and Country 1727 wood-effect laminate. Top and side extensions in Sand 3825 marble-effect porcelain stoneware.

Table extensible avec structure en stratifié effet métal Bronze 1F02 et stratifié effet bois Rustique 1727. Plateau et allonges latérales en céramique effet marbre Sable 3825.

Mesa extensible con estructura en laminado efecto metal Bronce 1F02 y laminado efecto madera Rústico 1727. Encimera y extensibles laterales en porcelánico efecto marmol Arena 3825.

Sedia / Chair / Chaise / Silla DENVER SE617
Panchetta / Bench / Banc / Banco DENVER 140 SP623



















TRITONE

TAVOLO ALLUNGABILE / EXTENDABLE TABLE
COD. TA516 - TOP 160/240X90 cm

Tavolo allungabile con struttura in laminato effetto metallo Bronzo 1F02 e Rustico 1727. Piano ed allunghe laterali in gres porcellanato effetto marmo Sabbia 3825.
 Extendable table with structure in Bronze 1F02 metal-effect laminate and Country 1727 wood-effect laminate. Top and side extensions in Sand 3825 marble-effect porcelain stoneware.
 Table extensible avec structure en stratifié effet métal Bronze 1F02 et stratifié effet bois Rustique 1727. Plateau et allonges latérales en céramique effet marbre Sable 3825.
 Mesa extensible con estructura en laminado efecto metal Bronce 1F02 y laminado efecto madera Rústico 1727.
 Encimera y extensibles laterales en porcelánico efecto marmol Arena 3825.

FINITURE / Finishes

ESTERNO BASE / External Basement laminato / laminate	 1F02 Bronzo Bronze	 1F22 Piombo Lead	 1F40 Argento Silver
INTERNO BASE / Internal Basement laminato / laminate	 1727 Rustico Country	 1F40 Argento Silver	 1728 Rustico bianco White country
PIANO / Top hpl / hpl	 1D21 Grafite Graphite	 1D24 Ghiaccio Ice Grey	 1D66 Corda Corda
PIANO / Top gres opaco / matt stoneware	 3822 Fiordibosco Fiordibosco	 3825 Sabbia Sand	 3808 Calacatta Calacatta
PIANO / Top gres lucido / glossy stoneware	 3808 Carrara Carrara	 3816 Alabastro Alabaster	 3818 Arabescato Arabesque
			 3660 Emperador Emperador

MISURE / Size

L 160/240 P 90 H 77 cm

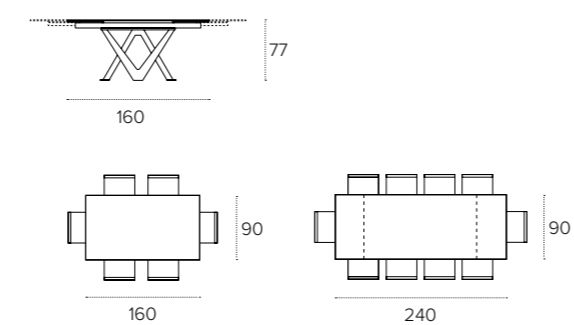

TWIST

TAVOLO ALLUNGABILE / EXTENDABLE TABLE
COD. TA206 - TOP 160/240X90 cm

Tavolo allungabile con basamento in agglomerato Grafite 3021 e piano girevole in gres porcellanato effetto marmo Arabescato 3818.

Extendable table with Graphite 3021 agglomerate base and Arabesque 3818 marble-effect porcelain gres stoneware rotating top.

Table extensible avec piètement en agglomerat Graphite 3021 et plateau pivotant en céramique effet marbre Arabesque 3818.

Mesa extensible con base en aglomerado Grafito 3021 y encimera giratoria en porcelánico efecto marmol Arabesca- to 3818.

Sedia/ Chair / Chaise/ Silla BRASILIA SE1A0.



TWIST

TAVOLO ALLUNGABILE / EXTENDABLE TABLE
COD. TA206 - TOP 160/240X90 cm

Tavolo allungabile con basamento in agglomerato Bianco 3008 e piano girevole in gres porcellanato effetto marmo Carrara 3828.
 Extendable table with White 3008 agglomerate base and Carrara 3828 marble-effect porcelain gres stoneware rotating top.
 Table extensible avec piètement en agglomerat Blanc 3008 et plateau pivotant en céramique effet marbre Carrare 3828.
 Mesa extensible con base en aglomerado Blanco 3008 y encimera giratoria en porcelánico efecto marmol Carrara 3828.

Sedia/ Chair / Chaise/ Silla DETROIT SE619.



FINITURE / Finishes

STRUTTURA / Frame
 agglomerato / agglomerate

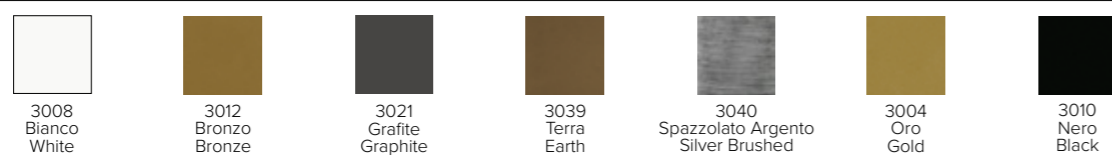

PIANO / Top
 gres opaco /
 matt stoneware



PIANO / Top
 gres lucido /
 glossy stoneware

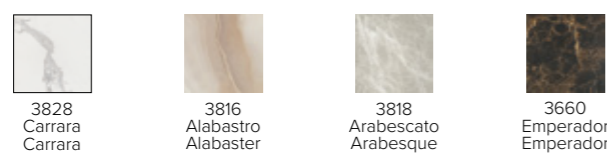

MISURE / Size **COD TA206**

L 130/200 P 90 H 75 cm

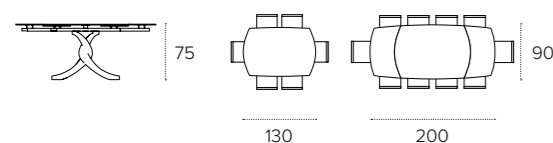

TOP GIREVOLE

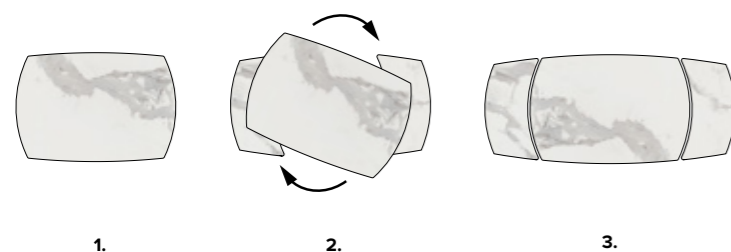

SCOPRI IL NOSTRO PIANO GIREVOLE!
 DISCOVER OUR ROTATING TOP!
 DÉCOUVREZ NOTRE PLATEAU PIVOTANT!
 DESCUBRE NUESTRA ENCIMERA GIRATORIA!



TWIST

TAVOLO ALLUNGABILE / EXTENDABLE TABLE
COD. TA204 - TOP 180/270X90 cm







Tavolo allungabile con basamento in agglomerato Oro 3004 e piano in gres porcellanato effetto marmo Calacatta 3808.
 Extendable table with Gold 3004 agglomerate base and Calacatta 3808 marble-effect porcelain gres stoneware top.
 Table extensible avec piètement en agglomerat Or 3004 et plateau en céramique eff et marbre Calacatta 3808.
 Mesa extensible con base en aglomerado Oro 3004 y encimera en porcelánico efecto marmol Calacatta 3808.

Sedia/ Chair / Chaise/ Silla MALAGA NEW SE1B0.



FINITURE / Finishes





STRUTTURA / Frame
 agglomerato / agglomerate

						
3008 Bianco White	3012 Bronzo Bronze	3021 Grafite Graphite	3039 Terra Earth	3040 Spazzolato Argento Silver Brushed	3004 Oro Gold	3010 Nero Black

PIANO / Top
 gres opaco /
 matt stoneware

	*disponibile solamente per versione 180 / only available for 180 version				*disponibile solamente per versione 160 / only available for 160 version
3521 Grafite Graphite		3808 Calacatta Calacatta	3822 Fiordibosco Fiordibosco	3825 Sabbia Sand	

PIANO / Top
 gres lucido /
 glossy stoneware

			
3828 Carrara Carrara	3816 Alabastro Alabaster	3818 Arabescato Arabesque	3660 Emperador Emperador

MISURE / Size **COD. TA204**

L 180/270 P 90 H 75 cm

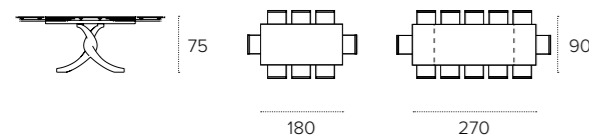

COD. TA205

L 160/240 P 90 H 75 cm

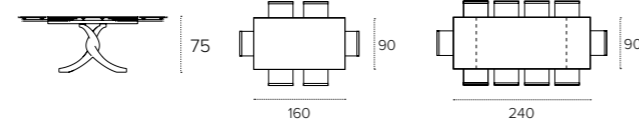

CALICE

TAVOLO ALLUNGABILE / EXTENDABLE TABLE
COD. TA200 - TOP 160/240X90 cm

Tavolo allungabile con basamento in agglomerato Spazzolato argento 3040 e piano girevole in gres porcellanato effetto marmo Fiordibosco 3822.

Extendable table with Silver brushed 3040 agglomerate base and Fiordibosco 3822 marble-effect porcelain gres stoneware rotating top.

Table extensible avec piètement en agglomerat Brossé argent 3040 et plateau pivotant en céramique eff et marbre Fiordibosco 3822.

Mesa extensible con base en aglomerado Cepillado plata 3040 y encimera giratoria en porcelánico efecto marmol Fiordibosco 3822.

Sedia/ Chair / Chaise / Silla BILBAO SE194.



CALICE

TAVOLO ALLUNGABILE / EXTENDABLE TABLE
COD. TA200 - TOP 160/240X90 cm

Tavolo allungabile con basamento in agglomerato Oro 3004 e piano girevole in gres porcellanato effetto marmo Sabbia 3825.

Extendable table with Gold 3004 agglomerate base and Sand 3825 marble-effect porcelain gres stoneware rotating top.

Table extensible avec piétement en agglomérat Or 3004 et plateau pivotant en céramique effet marbre Sable 3825.

Mesa extensible con base en aglomerado Oro 3004 y encimera giratoria en porcelánico efecto marmol Arena 3825.

Sedia/ Chair / Chaise/ Silla LOCARNO SE524.



CALICE

TAVOLO ALLUNGABILE / EXTENDABLE TABLE
COD. TA200 - TOP 160/240X90 cm

Tavolo allungabile con basamento in agglomerato Bianco 3008 e piano girevole in gres porcellanato effetto marmo Carrara 3828.

Extendable table with White 3008 agglomerate base and Carrara 3828 marble-effect porcelain gres stoneware rotating top.

Table extensible avec piétement en agglomerat Blanc 3008 et plateau pivotant en céramique effet marbre Carrare 3828.

Mesa extensible con base en aglomerado Blanco 3008 y encimera giratoria en porcelánico efecto marmol Carrara 3828.

Sedia/ Chair / Chaise/ Silla DENVER SE617.

Panchetta / Bench / Panquette / Banco DENVER SP617.



CALICE

TAVOLO ALLUNGABILE / EXTENDABLE TABLE
COD. TA200 - TOP 160/240X90 cm

Tavolo allungabile con basamento in agglomerato Bianco 3008 e piano girevole in gres porcellanato effetto marmo Carrara 3828.

Extendable table with White 3008 agglomerate base and Carrara 3828 marble-effect porcelain gres stoneware rotating top.

Table extensible avec piètement en agglomerat Blanc 3008 et plateau pivotant en céramique effet marbre Carrare 3828.

Mesa extensible con base en aglomerado Blanco 3008 y encimera giratoria en porcelánico efecto marmol Carrara 3828.

Sedia/ Chair / Chaise/ Silla DENVER SE617.

FINITURE / Finishes

STRUTTURA / Frame
 agglomerato / agglomerate



3008
Bianco
White



3010
Nero
Black



3012
Bronzo
Bronze



3021
Grafite
Graphite



3039
Terra
Earth



3040
Spazzolato Argento
Silver Brushed



3004
Oro
Gold

PIANO / Top
 gres opaco /
 matt stoneware



3808
Calacatta
Calacatta



3825
Sabbia
Sand



3822
Fiordibosco
Fiordibosco

PIANO / Top
 gres lucido /
 glossy stoneware



3828
Carrara
Carrara



3816
Alabastro
Alabaster



3818
Arabescato
Arabesque



3660
Emperador
Emperador

MISURE / Size

L 160/240 P 90 H 75/78 cm

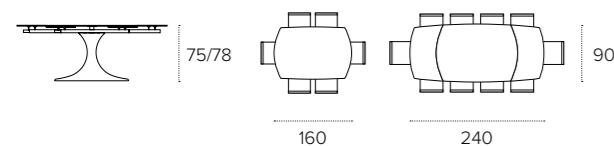

TOP GIREVOLE

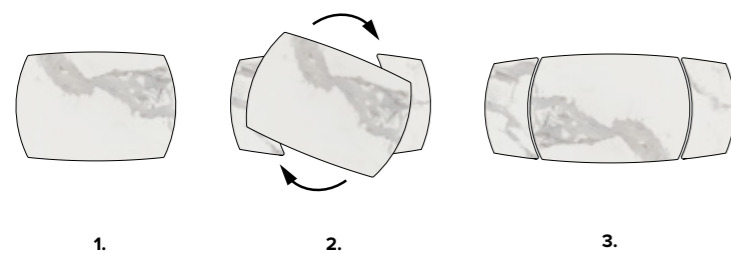

SCOPRI IL NOSTRO PIANO GIREVOLE!
 DISCOVER OUR ROTATING TOP!
 DÉCOUVREZ NOTRE PLATEAU PIVOTANT!
 DESCUBRE NUESTRA ENCIMERA GIRATORIA!



VORTICE

TAVOLO ALLUNGABILE / EXTENDABLE TABLE
COD. TA1B9 - TOP 160/240X90 cm

Tavolo allungabile con basamento in metallo Grafite 0122 e top girevole in gres porcellanato effetto marmo Fiordibosco 3822.

Extendable table with Graphite 0122 metal basement and Fiordibosco 3822 marble-effect stoneware rotating top.

Table extensible avec piètement en métal Graphite 0122 et plateau pivotant en céramique effet marbre Fiordibosco 3822.

Mesa extensible con base en metal Grafito 0122 y encimera giratoria en porcelanico efecto marmol Fiordibosco 3822.

Sedia / Chair / Chaise / Silla BRASILIA NEW SE1A7.



VORTICE

TAVOLO ALLUNGABILE / EXTENDABLE TABLE
COD. TA1B6 - TOP 130/200X90 cm

Tavolo allungabile con struttura in metallo verniciato Bianco 0108. Piano girevole ed allunghe laterali in gres porcellanato effetto marmo Carrara 3828.
Extendable table with White 0108 painted metal frame. Rotating top and side extensions in Carrara 3828 marble-effect porcelain gres stoneware.
Table extensible avec pied central et coulisses en métal peint Blanc 0108. Plateau pivotant et allonges latérales en céramique effet marbre Carrara 3828.
Mesa extensible con pata central y bastidor en metal pintado Blanco 0108. Encimera giratoria y extensibles laterales en gres porcelánico efecto marmol Carrara 3828.

Sedie/Chairs/Chaises/Sillas MALAGA SE195.



VORTICE

TAVOLO ALLUNGABILE / EXTENDABLE TABLE
COD. TA1B6

Piano girevole ed allunghe laterali in gres porcellanato effetto marmo Carrara 3828.

Extendable table with White 0108 painted metal frame.
 Rotating top and side extensions in Carrara 3828
 marble-effect porcelain gres stoneware.

Table extensible avec pied central et coulisses en
 métal peint Blanc 0108. Plateau pivotant et allonges
 latérales en céramique effet marbre Carrara 3828.

Mesa extensible con pata central y bastidor en metal
 pintado Blanco 0108. Encimera giratoria y extensibles
 laterales en gres porcelánico efecto marmol Carrara
 3828.

FINITURE / Finishes

STRUTTURA / Frame
 metallo / metal



0108
 Bianco
 White



0110
 Nero
 Black



0112
 Bronzo
 Bronze



0122
 Grafite
 Graphite



0139
 Terra
 Earth



0640
 Spazzolato Argento
 Silver Brushed

PIANO / Top
 gres opaco /
 matt stoneware



3521
 Grafite
 Graphite

*disponibile solamente
 per versione 130 / only
 available for 130 version



3822
 Fiordibosco
 Fiordibosco



3825
 Sabbia
 Sand



3808
 Calacatta
 Calacatta

PIANO / Top
 gres lucido /
 glossy stoneware



3828
 Carrara
 Carrara



3816
 Alabastro
 Alabaster



3818
 Arabescato
 Arabesque



3660
 Emperador
 Emperador

MISURE / Size

L 130/200 P 90 H 75/78 cm

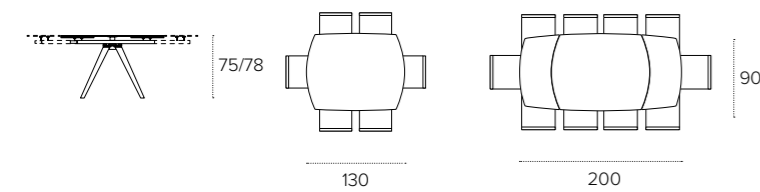

L 160/240 P 90 H 75/78 cm

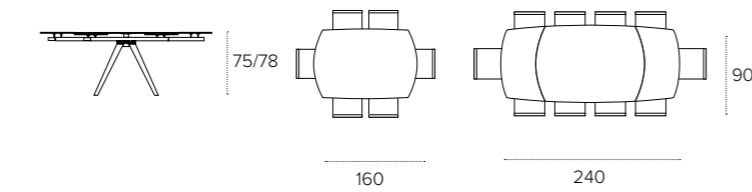

TOP GIREVOLE

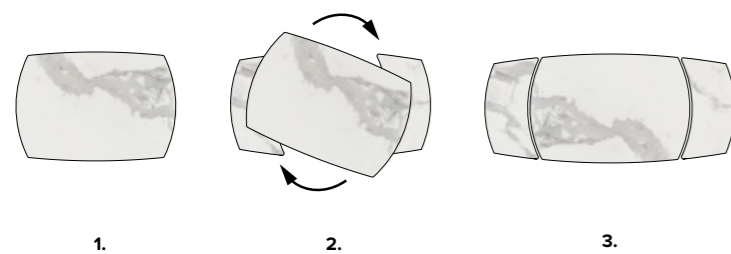

SCOPRI IL NOSTRO PIANO GIREVOLE!
 DISCOVER OUR ROTATING TOP!
 DÉCOUVREZ NOTRE PLATEAU PIVOTANT!
 DESCUBRE NUESTRA ENCIMERA GIRATORIA!

TORNADO

TAVOLO ALLUNGABILE / EXTENDABLE TABLE
COD. TA1B5 - TOP 130/200X90 cm

Tavolo allungabile con struttura in Silver spazzolato 0640. Piano ed allunghe laterali in gres porcellanato Arabescato 3640.

Extendable table with Brushed Silver 0640 frame. Top and side extensions in Arabesque 3618 porcelain stoneware.

Table extensible avec pied central et coulisses en Silver Brossé 0640. Plateau et allonges latérales en céramique Arabesque 3618.

Mesa extensible con pata central y bastidor en Silver Cepillado 0640. Encimera y extensibles laterales en gres porcelánico Arabescato 3618.

Sedie/Chairs/Chaises/Sillas Maiorca cod. SE190.



TORNADO

TAVOLO ALLUNGABILE / EXTENDABLE TABLE
COD. TA1B5 - TOP 130/200X90 cm

Tavolo allungabile con struttura in metallo verniciato Terra 0139.
 Piano girevole ed allunghe laterali in gres porcellanato effetto
 marmo Emperador 3660.

Extendable table with Earth 0139 painted metal frame. Rotating top
 and side extensions in Emperador 3660 marble-effect porcelain gres
 stoneware.

Table extensible avec pietement central et coulisses en métal peint
 Terre 0139. Plateau pivotant et allonges latérales en céramique effet
 marbre Emperador 3660.

Mesa extensible con pata central y bastidor en metal pintado Tierra
 0139. Encimera y extensibles laterales en porcelánico efecto marmol
 Emperador 3660.

Sedia/chair/chaise/silla LUCERNA SE514.

FINITURE / Finishes

STRUTTURA / Frame
 metallo / metal



0108
Bianco
White



0112
Bronzo
Bronze



0122
Grafite
Graphite



0139
Terra
Earth



0640
Spazzolato Argentato
Silver Brushed

PIANO / Top
 gres opaco /
 matt stoneware



3521
Grafite
Graphite



3822
Fiordibosco



3725
Sabbia
Sabbia



3808
Calacatta
Calacatta

PIANO / Top
 gres lucido /
 glossy stoneware



3828
Carrara
Carrara



3816
Alabastro
Alabaster



3818
Arabescato
Arabesque



3660
Emperador
Emperador

MISURE / Size

L 130/200 / 300 P 90 H 75 cm

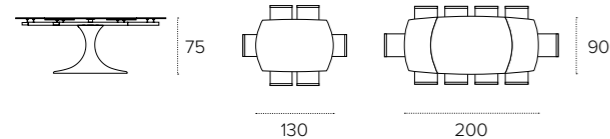

TOP GIREVOLE

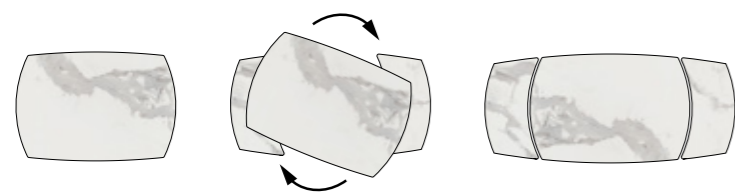

1.

2.

3.



SCOPRI IL NOSTRO PIANO GIREVOLE!
 DISCOVER OUR ROTATING TOP!
 DÉCOUVREZ NOTRE PLATEAU PIVOTANT!
 DESCUBRE NUESTRA ENCIMERA GIRATORIA!



CROSS

TAVOLO ALLUNGABILE / EXTENDABLE TABLE
COD. TA1D5 - TOP 160/240X90 cm

Tavolo allungabile con basamento in metallo Grafite 0122 e piano in gres porcellanato effetto marmo Fiordibosco 3822.

Extendable table with Graphite 0122 painted metal frame and Fiordibosco 3822 marble-effect porcelain gres stoneware top.

Table extensible avec piètement en métal Graphite 0122 et plateau en céramique effet marbre Fiordibosco 3822.
Mesa extensible con base en metal pintado Grafito 0122 y encimera en porcelánico efecto marmol Fiordibosco 3822.

Sedia / Chair / Chaise / Silla BILBAO SE194.



CROSS

TAVOLO ALLUNGABILE / EXTENDABLE TABLE
COD. TA1D6 - TOP 130/200X90 cm

Tavolo allungabile con basamento in metallo Terra 0139 e piano girevole in gres porcellanato effetto marmo Emperador 3660.

Extendable table with Earth 0139 painted metal frame and Emperador 3660 marble-effect porcelain stoneware rotating top.

Table extensible avec piètement en métal Terre 0139 et plateau pivotant en céramique effet marbre Emperador 3660.

Mesa extensible con base en metal pintado Tierra 0139 y encimera giratoria en porcelánico efecto marmol Emperador 3660.

Sedia / Chair / Chaise / Silla BELLINZONA SE507.
Madia / Sideboard / Buffet / Aparador ARTEMIDE MA115.



CROSS

TAVOLO ALLUNGABILE / EXTENDABLE TABLE
COD. TA1D6 - TOP 130/200X90 cm

Tavolo allungabile con basamento in metallo verniciato Grafite 0122 e piano girevole in gres porcellanato effetto marmo Arabescato 3828.











Extendable table with Graphite 0122 painted metal basement and Arabesque 3818 marble-effect porcelain gres stoneware rotating top.

Table extensible avec piètement en fer peint Graphite 0122 et plateau pivotant en céramique effet marbre Arabesque 3828.

Mesa extensible con base en metal pintado Grafito 0122 y encimera giratoria en porcelanico efecto marmol Arabescato 3828.

Sedia / Chair / Chaise / Silla GLAMOUR NEW SE199.







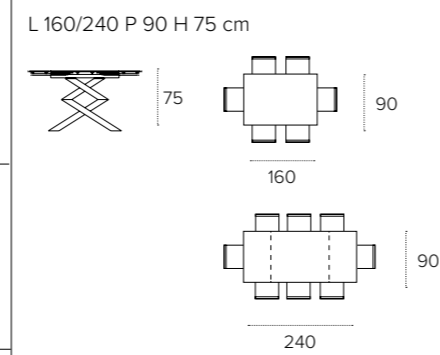



FINITURE / Finishes

STRUTTURA / Frame metallo / metal	 0108 Bianco White	 0112 Bronzo Bronze	 0122 Grafite Graphite	 0139 Terra Earth
PIANO / Top gres opaco / matt stoneware	 3822 Fiordibosco Fiordibosco	 3825 Sabbia Sand	 3808 Calacatta Calacatta	
PIANO / Top gres lucido / glossy stoneware	 3828 Carrara Carrara	 3816 Alabastro Alabaster	 3818 Arabescato Arabesque	 3660 Emperador Emperador

MISURE / Size **COD. TA1E3**



FINITURE / Finishes

STRUTTURA / Frame metallo / metal	 0108 Bianco White	 0112 Bronzo Bronze	 0122 Grafite Graphite	 0139 Terra Earth
PIANO / Top gres opaco / matt stoneware	 3521 Grafite Graphite	 3822 Fiordibosco Fiordibosco	 3825 Sabbia Sand	
PIANO / Top gres lucido / glossy stoneware	 3828 Carrara Carrara	 3816 Alabastro Alabaster	 3818 Arabescato Arabesque	 3660 Emperador Emperador

MISURE / Size **COD. TA1D5**

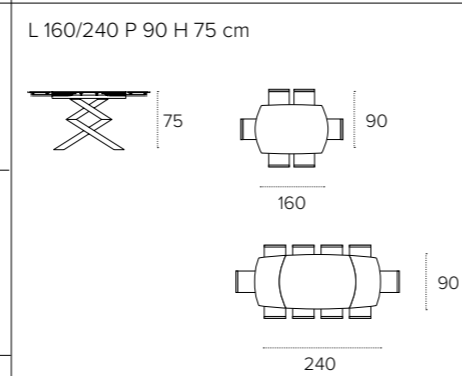

CROSS

TAVOLO ALLUNGABILE / EXTENDABLE TABLE
COD. TA1D6 - TOP 130/200X90 cm











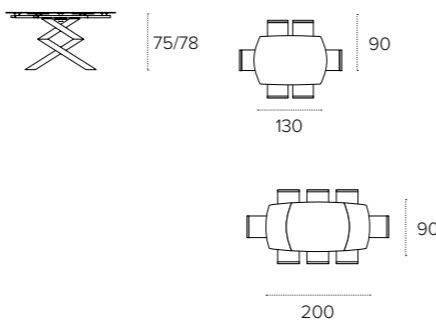

Tavolo allungabile con basamento in metallo verniciato Grafite 0122 e piano girevole in gres porcellanato effetto marmo Arabescato 3828.

Extendable table with Graphite 0122 painted metal basement and Arabesque 3818 marble-effect porcelain gres stoneware rotating top.

Table extensible avec piètement en fer peint Graphite 0122 et plateau pivotant en céramique effet marbre Arabesque 3828.

Mesa extensible con base en metal pintado Grafito 0122 y encimera giratoria en porcelanico efecto marmol Arabescato 3828.



FINITURE / Finishes				MISURE / Size COD. TA1D6	
STRUTTURA / Frame metallo / metal	 0108 Bianco White	 0112 Bronzo Bronze	 0122 Grafite Graphite	 0139 Terra Earth	L 130/200 P 90 H 75/78 cm 
PIANO / Top gres opaco / matt stoneware	 3521 Grafite Graphite	 3822 Fiordibosco Fiordibosco	 3825 Sabbia Sand	 3808 Calacatta Calacatta	
PIANO / Top gres lucido / glossy stoneware	 3828 Carrara Carrara	 3816 Alabastro Alabaster	 3818 Arabescato Arabesque	 3660 Emperador Emperador	
TOP GIREVOLE					

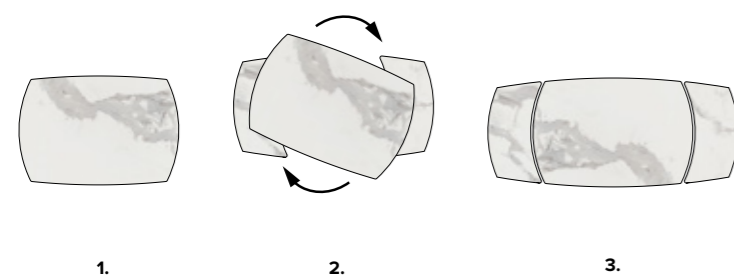

SCOPRI IL NOSTRO PIANO GIREVOLE!
 DISCOVER OUR ROTATING TOP!
 DÉCOUVREZ NOTRE PLATEAU PIVOTANT!
 DESCUBRE NUESTRA ENCIMERA GIRATORIA!

MINOSSE

TAVOLO ALLUNGABILE / EXTENDABLE TABLE
COD. TA1D3 - TOP 160/240X90 cm

Tavolo allungabile con basamento in metallo Bianco 0108 e piano in gres porcellanato effetto marmo Carrara 3828.

Extendable table with White 0108 metal basement and Carrara 3828 marble-effect stoneware top.
Table extensible avec piètement en métal Blanc 0108 et plateau en céramique effet marbre Carrare 3828.
Mesa extensible con base en metal Blanco 0108 y encimera en porcelánico efecto marmol Carrara 3828.

Sedia / Chair / Chaise / Silla PORTLAND SE620.



MINOSSE

TAVOLO ALLUNGABILE / EXTENDABLE TABLE
COD. TA1D3 - TOP 160/240X90 cm

Tavolo allungabile con basamento in metallo Grafite 0122 e piano in gres porcellanato effetto marmo Arabescato 3818.

Extendable table with Graphite 0122 metal basement and Arabesque 3818 marble-effect stoneware top.
Table extensible avec piètement en métal Graphite 0122 et plateau en céramique effet marbre Arabesque 3818.
Mesa extensible con base en metal Grafito 0122 y encimera en porcelánico efecto marmol Arabescato 3818.

Sedia / Chair / Chaise / Silla SEATTLE SE618.



MINOSSE

TAVOLO ALLUNGABILE / EXTENDABLE TABLE
COD. TA1D3 - TOP 160/240X90 cm

Tavolo allungabile con basamento in metallo Grafite 0122 e piano in gres porcellanato effetto marmo Arabescato 3818.













Extendable table with Graphite 0122 metal basement and Arabesque 3818 marble-effect stoneware top.

Table extensible avec piètement en métal Graphite 0122 et plateau en céramique effet marbre Arabesque 3818.

Mesa extensible con base en metal Grafito 0122 y encimera en porcelánico efecto marmol Arabescato 3818.

Sedia / Chair / Chaise / Silla SEATTLE SE618.

FINITURE / Finishes







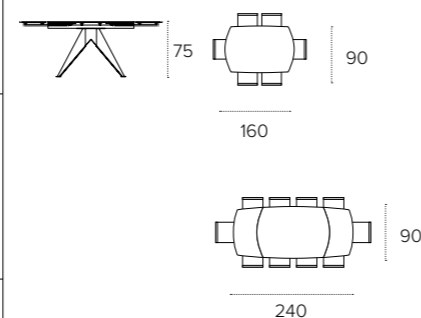





STRUTTURA / Frame metallo / metal	 0108 Bianco White	 0112 Bronzo Bronze	 0122 Grafite Graphite	 0139 Terra Earth	 0640 Silver Spazzolato Brushed Silver
PIANO / Top gres opaco / matt stoneware	 3521 Grafite Graphite	 3822 Fiordibosco Fiordibosco	 3825 Sabbia Sand		
PIANO / Top gres lucido / glossy stoneware	 3828 Carrara Carrara	 3816 Alabastro Alabaster	 3818 Arabescato Arabesque	 3660 Emperador Emperador	
PIANO / Top vetro / glass	 2108 Extra bianco Extra white				

MISURE / Size **COD. TA1D3**

L 160/240 P 90 H 75 cm



FINITURE / Finishes

STRUTTURA / Frame metallo / metal	 0108 Bianco White	 0112 Bronzo Bronze	 0122 Grafite Graphite	 0139 Terra Earth	 0640 Silver Spazzolato Brushed Silver
PIANO / Top gres opaco / matt stoneware	 3822 Fiordibosco Fiordibosco	 3825 Sabbia Sand	 3808 Calacatta Calacatta		
PIANO / Top gres lucido / glossy stoneware	 3808 Carrara Carrara	 3816 Alabastro Alabaster	 3818 Arabescato Arabesque	 3660 Emperador Emperador	

MISURE / Size **COD. TA1E5**

L 160/240 P 90 H 75 cm

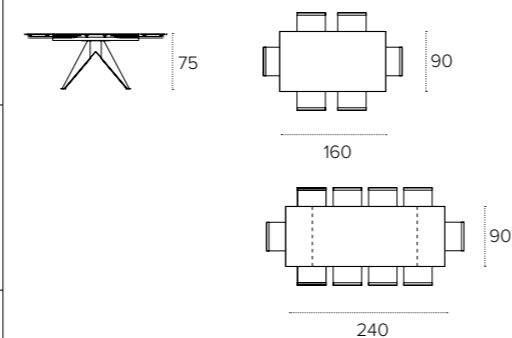

POSEIDONE

TAVOLO ALLUNGABILE / EXTENDABLE TABLE
COD. TA1A0 - TOP 160/240X90 cm

Tavolo allungabile con struttura in metallo verniciato Bianco 0108.

Piano a botticella ed allunghe laterali in gres porcellanato effetto marmo Calacatta 3808.

Extendable table with White 0108 painted metal base.

Barrel-shaped top and side extensions in Calacatta 3808 marble-effect stoneware.

Table extensible avec piètement en fer peint Blanc

0108. Plateau et allonges latérales en forme de tonneau en céramique effet marbre Calacatta 3808.

Mesa extensible con base en metal pintado Blanco

0108. Encimera y extensibles laterales en forma de barril en porcelánico efecto marmol Calacatta 3808.

Sedia / Chair / Chaise / Silla BILBAO SE194.



POSEIDONE

TAVOLO ALLUNGABILE / EXTENDABLE TABLE
COD. TA1A3 - TOP 120/200X90 cm

Tavolo allungabile con basamento centrale in metallo Grafite 0122, piano ed allunghe a botticella in gres porcellanato effetto marmo Fiordibosco 3822.

Extendable table with Graphite 0122 painted metal central base, barrel-shaped top and side extensions in Fiordibosco 3822 marble-effect stoneware.

Table extensible avec piètement central en fer peint Graphite 0122, plateau et allonges à forme de tonneau en céramique effet marbre Fiordibosco 3822.

Mesa extensible con pata central en metal pintado Grafito 0122 y encimera en forma de barril en porcelánico efecto marmol Fiordibosco 3822.

Sedia / Chair / Chaise / Silla LUGANO SE504



POSEIDONE

TAVOLO ALLUNGABILE / EXTENDABLE TABLE
COD. TA1A3 - TOP 120/200X90 cm

Tavolo allungabile con struttura in metallo Spazzolato argento 0640.

Piano ed allunghe laterali a botticella in gres porcellanato effetto marmo Arabescato 3818.

Extendable table with Silver brushed 0640 painted metal base. Barrel-shaped top and side extensions in Arabesque 3818 marble-effect stoneware.

Table extensible avec piètement en métal Brossé argent 0640. Plateau et allonges latérales en forme de tonneau en céramique effet marbre Arabesque 3818.

Mesa extensible con base en metal Cepillado plata 0640. Encimera y extensibles laterales en forma de barril en porcelánico efecto marmol Arabescato 3818.

Sedia / Chair / Chaise / Silla VIENNA SE608.



POSEIDONE

TAVOLO ALLUNGABILE / EXTENDABLE TABLE
COD. TA1A0 - TOP 160/240X90 cm













Tavolo allungabile con struttura in metallo Spazzolato argento 0640 , piano ed allunghe in gres porcellanato effetto marmo Arabescato 3818.

Extendable table with Silver brushed 0640 painted metal base, top and side extensions in Arabesque 3818 marble-effect stoneware.

Table extensible avec piètement en metal Brossé argent 0640 et plateau en céramique effet marbre Arabesque 3818.

Mesa extensible con base en metal Cepillado plata 0640 y encimera en porcelánico efecto marmol Arabescato 3818.







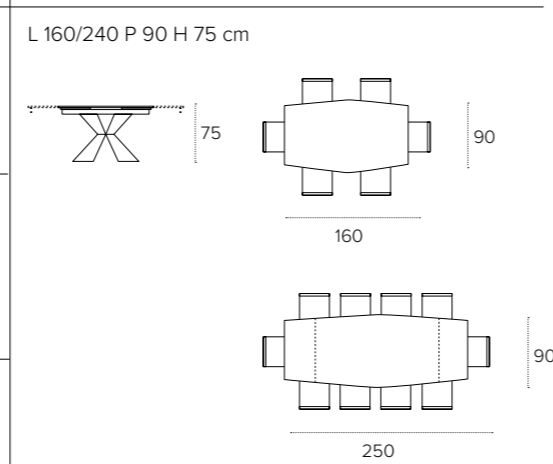





FINITURE / Finishes

STRUTTURA / Frame metallo / metal	 0108 Bianco White	 0112 Bronzo Bronze	 0122 Grafite Graphite	 0139 Terra Earth	 0640 Silver Spazzolato Brushed Silver
PIANO / Top gres opaco / matt stoneware	 3521 Grafite Graphite	 3822 Fiordibosco Fiordibosco	 3825 Sabbia Sand		
PIANO / Top gres lucido / glossy stoneware	 3828 Carrara Carrara	 3816 Alabastro Alabaster	 3818 Arabescato Arabesque	 3660 Emperador Emperador	
PIANO / Top vetro / glass	 2108 Extra bianco Extra white				

MISURE / Size



FINITURE / Finishes

STRUTTURA / Frame metallo / metal	 0108 Bianco White	 0112 Bronzo Bronze	 0122 Grafite Graphite	 0640 Silver Spazzolato Brushed Silver
PIANO / Top gres opaco / matt stoneware	 3521 Grafite Graphite	 3822 Fiordibosco Fiordibosco	 3825 Sabbia Sand	 3808 Calacatta Calacatta
PIANO / Top gres lucido / glossy stoneware	 3828 Carrara Carrara	 3816 Alabastro Alabaster	 3818 Arabescato Arabesque	
PIANO / Top vetro / glass	 2108 Extra bianco Extra white			

MISURE / Size

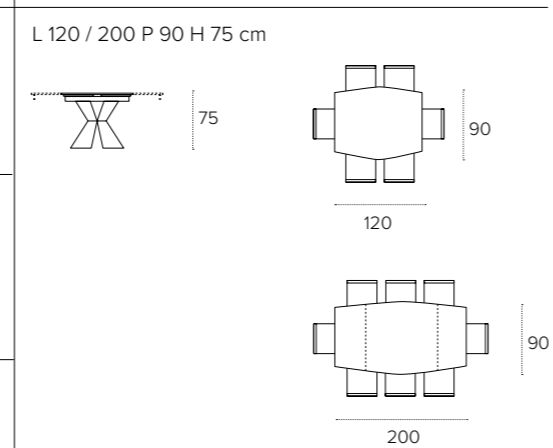

COPERNICO

TAVOLO ALLUNGABILE / EXTENDABLE TABLE
COD. TA196 - TOP 160/240X90 cm

Tavolo allungabile con basamento centrale in MDF laccato Grafite 1221, piano ed allunghe a botticella in gres porcellanato Grafite 3521.

Extendable table with Graphite 1221 lacquered MDF central basement, barrel-shaped top and side extensions in Graphite 3521 porcelain gres stoneware.

Table extensible avec piètement central en MDF laqué Graphite 1221, plateau et allonges à forme de tonneau en céramique Graphite 3521.

Mesa extensible con pata central en MDF lacado Grafito 1221 y encimera en forma de barril en porcelánico Grafito 3521.

Sedia / Chair / Chaise / Silla LUGANO SE504.



COPERNICO

TAVOLO ALLUNGABILE / EXTENDABLE TABLE
COD. TA196 - TOP 160/240X90 cm

Tavolo allungabile con basamento centrale in MDF laccato Grafite 1221, piano ed allunghe a botticella in gres porcellanato Grafite 3521.

Extendable table with Graphite 1221 lacquered MDF central basement, barrel-shaped top and side extensions in Graphite 3521 porcelain gres stoneware.

Table extensible avec piétement central en MDF laqué Graphite 3521, plateau et allonges à forme de tonneau en céramique Graphite 3521.

Mesa extensible con pata central en MDF lacado Grafito 1221 y encimera en forma de barril en porcelanico Grafito 3521.

Sedia / Chair / Chaise / Silla LUGANO SE504.

FINITURE / Finishes

STRUTTURA / Frame
 legno laccato /
 laquered wood



1208
 Bianco
 White



1212
 Bronzo
 Bronze



1221
 Grafite
 Graphite

PIANO / Top
 gres opaco /
 matt stoneware



3521
 Grafite
 Graphite



3822
 Fiordibosco
 Fiordibosco



3825
 Sabbia
 Sand

PIANO / Top
 gres lucido /
 glossy stoneware



3828
 Carrara
 Carrara



3816
 Alabastro
 Alabaster



3818
 Arabescato
 Arabesque



3660
 Emperador
 Emperador

PIANO / Top
 vetro / glass



2108
 Extra bianco
 Extra white

MISURE / Size

L 160 / 250 P 90 H 75 cm

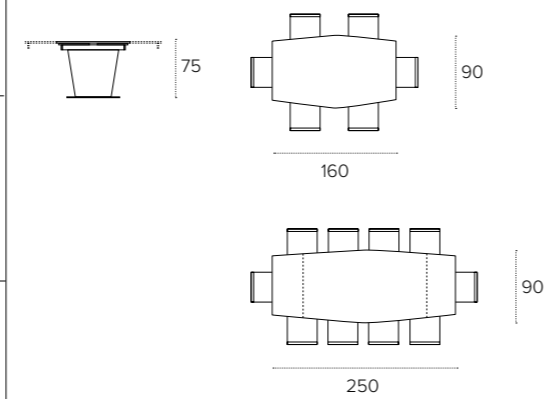

COPERNICO

TAVOLO ALLUNGABILE / EXTENDABLE TABLE
COD. TA184 - TOP 120/200X90 cm

Tavolo allungabile con basamento centrale in MDF laccato Bronzo 1212, piano ed allunghe a botticella in gres porcellanato effetto marmo Alabastro 3816.

Extendable table with Bronze 1212 lacquered MDF central base, barrel-shaped top and side extensions in Alabaster 3816 marble-effect stoneware.

Table extensible avec piètement central en MDF laqué Bronze 1212, plateau et allonges à forme de tonneau en céramique effet marbre Albatre 3816.

Mesa extensible con pata central en metal pintado Bronce 1212 y encimera en forma de barril en porcelánico efecto marmol Alabastro 3816.

Sedia / Chair / Chaise / Silla FUTURA SE800.



COPERNICO

TAVOLO ALLUNGABILE / EXTENDABLE TABLE
 COD. TA184 - TOP 120/200X90 cm

Tavolo allungabile con basamento centrale in MDF laccato Bianco 1208, piano ed allunghe a botticella in vetro temperato Extra bianco 2108.

Extendable table with White 1208 lacquered MDF central base, barrel-shaped top and side extensions in Extra white 2108 tempered glass.

Table extensible avec piètement central en MDF laqué Blanc 1208, plateau et allonges à forme de tonneau en verre trempé Extra blanc 2108.

Mesa extensible con pata central en metal pintado Blanco 1208 y encimera en forma de barril en cristal templado Extra blanco 2108.

Sedia / Chair / Chaise / Silla VIENNA SE608.

FINITURE / Finishes

STRUTTURA / Frame
 legno laccato /
 laquered wood



1208
 Bianco
 White



1212
 Bronzo
 Bronze



1221
 Grafite
 Graphite

PIANO / Top
 gres opaco /
 matt stoneware



3521
 Grafite
 Graphite



3822
 Fiordibosco
 Fiordibosco



3825
 Sabbia
 Sand



3808
 Calacatta
 Calacatta

PIANO / Top
 gres lucido /
 glossy stoneware



3828
 Carrara
 Carrara



3816
 Alabastro
 Alabaster



3818
 Arabescato
 Arabesque

PIANO / Top
 vetro / glass



2108
 Extra bianco
 Extra white

MISURE / Size

L 120 / 200 P 90 H 75 cm



75

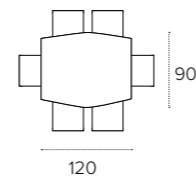

120

90

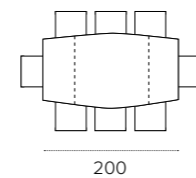

200

90



ETTORE

TAVOLO ALLUNGABILE / EXTENDABLE TABLE
COD. TA1D8 - TOP 160/360X90 cm

Tavolo super allungabile con struttura in metallo verniciato Grafite 0122. Piano ed allunghe centrali in laminato spazzolato Vulcano 1L62.

Super-extendable table with structure in Graphite 0122 painted metal. Top and central extensions in Volcano 1L62 brushed laminate.

Table super-extensible avec structure en fer peint Graphite 0122. Plateau et allonges centrales en stratifié brossé Volcan 1L62.

Mesa super-extensible con estructura en metal pintado Grafito 0122.

Encimera y extensibles centrales en laminado cepillado Volcan 1L62.

Sedia / Chair / Chaise / Silla MALAGA SE195.



ETTORE

TAVOLO ALLUNGABILE / EXTENDABLE TABLE
COD. TA1D8 - TOP 160/360X90 cm

Tavolo super allungabile con struttura in metallo verniciato Grafite 0122. Piano ed allunghe centrali in laminato effetto legno Rustico 1727.

Super-extendable table with structure in Graphite 0122 painted metal. Top and central extensions in Country 1727 wood-effect laminate.

Table super-extensible avec structure en fer peint Graphite 0122. Plateau et

allonges centrales en stratifié effet bois Rustique 1727.

Mesa super-extensible con estructura en metal pintado Grafito 0122. Encimera y extensibles centrales en laminado efecto madera Rustico 1727.

Sedia / Chair / Chaise / Silla BILBAO SE194.



ETTORE

TAVOLO ALLUNGABILE / EXTENDABLE TABLE
COD. TA1D8 - TOP 160/360X90 cm

Tavolo super allungabile con struttura in metallo verniciato Terra 0139. Piano ed allunghe centrali in laminato spazzolato Argilla 1L46.

Super-extendable table with structure in Earth 0139 painted metal. Top and central extensions in Clay 1L46 brushed laminate.

Table super-extensible avec structure en fer peint Terre 0139. Plateau et allonges centrales en stratifié brossé Argile 1L46.

Mesa super-extensible con estructura en metal pintado Tierra 0139.

Encimera y extensibles centrales en laminado cepillado Arcilla 1L46.

Sedia / Chair / Chaise / Silla LOCARNO SE524.



FINITURE / Finishes

STRUTTURA / Frame
 metallo / metal



0108
 Bianco
 White



0112
 Bronzo
 Bronze



0121
 Grafite
 Graphite



0139
 Terra
 Earth

PIANO / Top
 laminato effetto legno /
 wood-effect laminate



1727
 Rustico
 Country



1728
 Rustico Bianco
 White Country

PIANO / Top
 laminato spazzolato /
 brushed laminate



1L46
 Argilla
 Clay



1L62
 Vulcano
 Volcano

MISURE / Size

L 160 / 210 / 260 / 310 / 360 P 90 H 75 cm

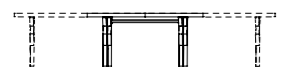

75

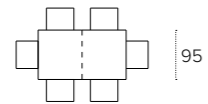

160

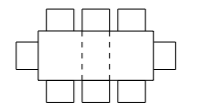

210

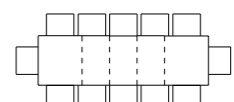

310

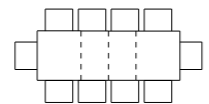

260

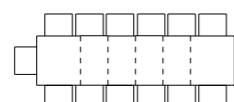

360

90

90



SCOPRI IL SISTEMA DI APERTURA!
 DISCOVER THE OPENING SYSTEM!
 DÉCOUVREZ LE SYSTÈME D'OUVERTURE!
 ¡DESCUBRE EL SISTEMA DE APERTURA!



SIGMA

TAVOLO ALLUNGABILE / EXTENDABLE TABLE
COD. TA517 - TOP 180/260X90 cm

Tavolo allungabile con struttura in laminato effetto metallo Bronzo 1F02. Piano ed allunghe laterali in laminato effetto legno Rustico 1727.

Extendable table with structure in Bronze 1F02 metal-effect laminate. Top and side extensions in Country 1727 wood-effect laminate.

Table extensible avec structure en stratifié effet métal Bronze 1F02. Plateau et allonges latérales en stratifié effet bois Rustique 1727.

Mesa extensible con estructura en laminado efecto metal Bronce 1F02. Encimera y extensibles laterales en laminado efecto madera Rústico 1727.

Sedia / Chair / Chaise / Silla DALLAS SE616
Poltroncina / Armchair / Fauteuil / Sillón DALLAS PT616
Madia / Sideboard / Buffet / Aparador MODUS MA108



SIGMA

TAVOLO ALLUNGABILE / EXTENDABLE TABLE
COD. TA517 - TOP 180/260X90 cm

Tavolo allungabile con struttura in laminato effetto metallo
Piombo 1F22. Piano ed allunghe laterali in laminato effetto
legno Castoro 1724.

Extendable table with central leg in Lead 1F22 metal-effect
laminated. Top and side extensions in Beaver 1724 wood-
effect laminate.

Table extensible avec structure en stratifié effet métal
Plomb 1F22. Plateau et allonges latérales en stratifié effet
bois Castor 1724.

Mesa extensible con estructura en laminado efecto metal
Plomo 1F22. Encimera y extensibles laterales en laminado
efecto madera Castor 1724.

Sedia / Chair / Chaise / Silla DENVER SE617



SIGMA

TAVOLO ALLUNGABILE / EXTENDABLE TABLE
COD. TA517 - TOP 180/260X90 cm

Tavolo allungabile con struttura in laminato effetto metallo Piombo 1F22. Piano ed allunghe laterali in laminato effetto legno Castoro 1724.

Extendable table with central leg in Lead 1F22 metal-effect laminate. Top and side extensions in Beaver 1724 wood-effect laminate.

Table extensible avec structure en stratifié effet métal Plomb 1F22. Plateau et allonges latérales en stratifié effet bois Castor 1724.

Mesa extensible con estructura en laminado efecto metal Plomo 1F22. Encimera y extensibles laterales en laminado efecto madera Castor 1724.

Sedia / Chair / Chaise / Silla DENVER SE617



FINITURE / Finishes

STRUTTURA / Frame
laminato effetto metallo /
metal-effect laminate



1F02
Bronzo
Bronze



1F22
Piombo
Lead



1F40
Argento
Silver

Laminato
effetto legno
Wood-effect
laminate



1728
Rustico Bianco
White Country

PIANO / Top
laminato effetto legno /
wood-effect laminate



1724
Castoro
Beaver



1727
Rustico
Country



1728
Rustico Bianco
White Country

MISURE / Size

L 180/250 P 90 H 77 cm

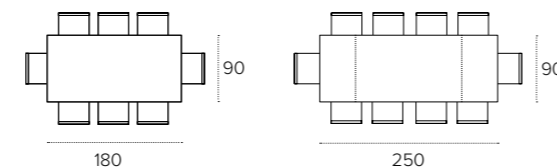
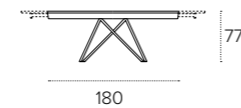

SIGMA

TAVOLO ALLUNGABILE / EXTENDABLE TABLE
COD. TA517 - TOP 180/260X90 cm

Tavolo allungabile con struttura in laminato effetto legno Rustico bianco 1728. Piano ed allunghe laterali in laminato effetto legno Rustico bianco 1728.

Extendable table with central leg in Country white 1728 wood-effect laminate. Top and side extensions in Country white 1728 wood-effect laminate.

Table extensible avec structure en stratifié effet bois Rustique blanc 1728. Plateau et allonges latérales en stratifié effet bois Rustique blanc 1728.

Mesa extensible con estructura en laminado efecto madera Rustico blanco 1728. Encimera y extensibles laterales en laminado efecto madera Rustico blanco 1728.

SIGMA

TAVOLO ALLUNGABILE / EXTENDABLE TABLE
COD. TA521 - TOP 180/280X90 cm

Tavolo allungabile con struttura in laminato effetto metallo
Bronzo 1F02. Piano ed allonghe laterali in laminato
spazzolato Argilla 1L46.

Extendable table with central leg in Bronze 1F02 metal-
effect laminate. Top and side extensions in Clay 1L46
brushed laminate.

Table extensible avec structure en stratifié effet métal
Bronze 1F02. Plateau et allonges latérales en stratifié
brossé Argile 1L46.

Mesa extensible con estructura en laminado efecto metal
Bronze 1F02. Encimera y extensibles laterales en laminado
cepillado Argila 1L46.

Sedia / Chair / Chaise / Silla BELLINZONA SE507



SIGMA

TAVOLO ALLUNGABILE / EXTENDABLE TABLE
COD. TA521 - TOP 180/280X90 cm

Tavolo allungabile con struttura in laminato effetto metallo Argento 1F40. Piano ed allunghe laterali in laminato spazzolato Vulcano 1L62.

Extendable table with central leg in Silver 1F40 metal-effect laminate. Top and side extensions in Volcano 1L62 brushed laminate.

Table extensible avec structure en stratifié effet métal Argent 1F40. Plateau et allonges latérales en stratifié brossé Volcan 1L62.

Mesa extensible con estructura en laminado efecto metal Plata 1F40. Encimera y extensibles laterales en laminado cepillado Volcan 1L62.

Sedia / Chair / Chaise / Silla BILBAO SE194



FINITURE / Finishes

STRUTTURA / Frame
 laminato effetto metallo /
 metal-effect laminate



1F02
Bronzo
Bronze



1F22
Piombo
Lead



1F40
Argento
Silver

laminato effetto legno /
 wood-effect laminate



1728
Rustico Bianco
White Country

PIANO / Top
 laminato effetto legno /
 wood-effect laminate



1724
Castoro
Beaver



1727
Rustico
Country



1728
Rustico Bianco
White Country

PIANO / Top
 laminato spazzolato /
 brushed laminate



1L46
Argilla
Clay



1L62
Vulcano
Volcano

SOLO PER TA521 - TA522
 ONLY FOR TA521 - TA522

MISURE / Size **COD. TA521**

L 180/280 P 90 H 77 cm

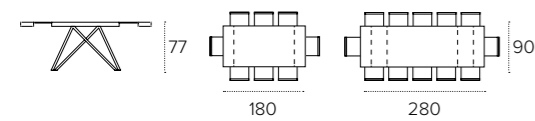

COD. TA522

L 180/240 P 90 H 77 cm

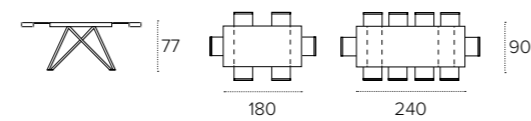

ASTERION

TAVOLO ALLUNGABILE / EXTENDABLE TABLE
COD. TA194 - TOP 180/280X90 cm

Tavolo allungabile con struttura in legno, piano ed allunghe in laminato effetto legno Rustico bianco 1728.
Extendable table with wooden frame and 1728 White country wood-effect laminate top and side extensions.
Table extensible avec structure en bois. Piètement, plateau et allonges latérales en stratifié effet bois Rustique blanc 1728.
Mesa extensible con estructura en madera. Patas, encimera y extensibles laterales en laminado efecto madera Rustico blanco 1728.

Sedia/Chair/Chaise/Silla GINEVRA SE515.



ASTERION

TAVOLO ALLUNGABILE / EXTENDABLE TABLE
COD. TA194 - TOP 180/280X90 cm

Tavolo allungabile con struttura in legno, piano ed allunghe in laminato effetto legno Castoro 1724.
Extendable table with wooden frame and 1724 Beaver wood-effect laminate top and side extensions.
Table extensible avec structure en bois. Piètement, plateau et allonges latérales en stratifié effet bois Castor 1724.
Mesa extensible con estructura en madera. Patas, encimera y extensibles laterales en laminado efecto madera Castor 1724.

Sedia/Chair/Chaise/Silla BELLINZONA SE507.



ASTERION

TAVOLO ALLUNGABILE / EXTENDABLE TABLE
COD. TA194 - 180/280X90 cm

Tavolo allungabile con struttura in legno, piano ed allunghe in laminato effetto legno Castoro 1724.
Extendable table with wooden frame and 1724 Beaver wood-effect laminate top and side extensions.
Table extensible avec structure en bois. Piètement, plateau et allonges latérales en stratifié effet bois Castor 1724.
Mesa extensible con estructura en madera. Patas, encimera y extensibles laterales en laminado efecto madera Castor 1724.

FINITURE / Finishes

STRUTTURA E PIANO /
Frame and top finishing



1724
Castoro
Beaver



1727
Rustico
Country



1728
Rustico bianco
White country

MISURE / Size

L 180/280 P 90 H 75 cm



75

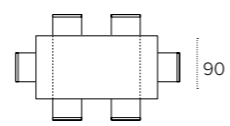

90

180

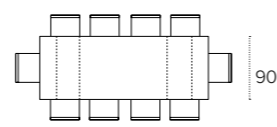

90

280



ASTERION

TAVOLO ALLUNGABILE / EXTENDABLE TABLE
COD. TA1C5 - TOP 160/240X90 cm

Tavolo allungabile con struttura in legno, piano ed allunghe in laminato effetto legno Rustico 1727.
Extendable table with wooden frame and 1727 Country wood-effect laminate top and side extensions.
Table extensible avec structure en bois. Piètement, plateau et allonges latérales en stratifié effet bois Rustique 1727.
Mesa extensible con estructura en madera. Patas, encimera y extensibles laterales en laminado efecto madera Rustico 1727.

Sedia/Chair/Chaise/Silla VIENNA SE608.
Madia/Sideboard/Bufet/Aparador MODUS MA108.



ASTERION

TAVOLO ALLUNGABILE / EXTENDABLE TABLE
COD. TA1C5 - TOP 160/240X90 cm

Tavolo allungabile con struttura in legno, piano ed allunghe in laminato effetto legno Rustico bianco 1728. Extendable table with wooden frame and 1728 White country wood-effect laminate top and side extensions. Table extensible avec structure en bois. Piètement, plateau et allonges latérales en stratifié effet bois Rustique blanc 1728.

Mesa extensible con estructura en madera. Patas, encimera y extensibles laterales en laminado efecto madera Rustico blanco 1728.

Sedia/Chair/Chaise/Silla MALAGA SE195.

FINITURE / Finishes

STRUTTURA E PIANO /
Frame and top finishing



1724
Castoro
Beaver



1727
Rustico
Country



1728
Rustico bianco
White country

MISURE / Size

L 160/240 P 90 H 75 cm

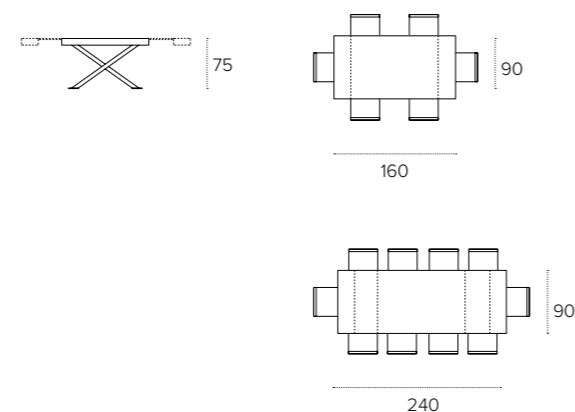

APOLLO

TAVOLO ALLUNGABILE / EXTENDABLE TABLE
COD. TA1C3 - TOP 180/270X90 cm

Tavolo allungabile in legno con basamento in metallo
Spazzolato argento 0640. Piano ed allunghe laterali in
laminato effetto legno Castoro 1724.

Extendable wooden table with Brushed Silver 0640
central leg. Top and side extensions in Beaver 1724 wood-
effect laminate.

Table extensible en bois avec piètement central en fer
Brossé argent 0640. Plateau et allonges latérales en
stratifié effet bois Castor 1724.

Mesa extensible de madera con pata central en metal
Cepillado plata 0640. Encimera y extensibles laterales en
laminado efecto madera Castor 1724.

Sedie/Chairs/Chaises/Sillas MAIORCA SE190.



APOLLO

TAVOLO ALLUNGABILE / EXTENDABLE TABLE
COD. TA1C3 - TOP 180/270X90 cm

Tavolo allungabile in legno con basamento in metallo
Terra 0139. Piano ed allunghe laterali in laminato effetto
legno Rustico 1727.

Extendable wooden table with Earth 0139 central leg.
Top and side extensions in Country 1727 wood-effect
laminated.

Table extensible en bois avec piètement central en fer
Terre 0139. Plateau et allonges latérales en stratifié effet
bois Rustique 1727.

Mesa extensible de madera con pata central en metal
Tierra 0139. Encimera y extensibles laterales en laminado
efecto madera Rustico 1727.

Sedia/Chair/Chaise/Silla SALISBURGO SE506.
Poltroncina/Armchair/Fauteuil/Sillón SALISBURGO
PT508.

Madia/Sideboard/Bufet/Aparador VERSUS210 MA101.



APOLLO

TAVOLO ALLUNGABILE / EXTENDABLE TABLE
COD. TA1C4 - TOP 160/240X90 cm

Tavolo allungabile in legno con basamento in metallo Grafite 0122. Piano ed allunghe laterali in laminato effetto legno Castoro 1724.

Extendable wooden table with Graphite 0122 painted metal central leg. Top and side extensions in Beaver 1724 wood-effect laminate.

Table extensible en bois avec piètement central en fer Graphite 0122. Plateau et allonges latérales en stratifié effet bois Castor 1724.

Mesa extensible de madera con pata central en metal Gráfico 0122. Encimera y extensibles laterales en laminado efecto madera Castor 1724.

Sedie/Chairs/Chaises/Sillas LUGANO SE524.
Madia/Sideboard/Bufet/Aparador VERSUS MA100.



APOLLO

TAVOLO ALLUNGABILE / EXTENDABLE TABLE
COD. TA1C4 - TOP 160/240X90 cm

Tavolo allungabile in legno con basamento in metallo
Bianco 0108. Piano ed allunghe laterali in laminato effetto
legno Rustico bianco 1728.

Extendable wooden table with White 0108 central leg. Top
and side extensions in White country 1728 wood-effect
laminated.

Table extensible en bois avec piètement central en fer
laqué Blanc 0108. Plateau et allonges latérales en stratifié
effet bois Rustique blanc 1728.

Mesa extensible de madera con pata central en metal
Blanco 0108. Encimera y extensibles laterales en laminado
efecto madera Rustico blanco 1728.

Sedia/Chair/Chaise/Silla BELLINZONA SE507.



APOLLO

TAVOLO ALLUNGABILE / EXTENDABLE TABLE
COD. TA1C4 - TOP 160/240X90 cm

Piano ed allunghe laterali in laminato effetto legno Rustico bianco 1728.

Top and side extensions in White country 1728 wood-effect laminate.

Plateau et allonges latérales en stratifié effet bois Rustique blanc 1728.

Encimera y extensibles laterales en laminado efecto madera Rustico blanco 1728.

FINITURE / Finishes

STRUTTURA / Frame
 metallo / metal



0108
 Bianco
 White



0112
 Bronzo
 Bronze



0122
 Grafite
 Graphite



0139
 Terra
 Earth



0640
 Spazzolato Argento
 Silver Brushed



0110
 Nero
 Black

PIANO / Top
 laminato / laminate



1724
 Castoro
 Beaver



1727
 Rustico
 Country



1728
 Rustico bianco
 White country

PIANO / Top
 laminato spazzolato /
 brushed laminate



1L62
 Argilla
 Clay



1L46
 Vulcano
 Volcano

MISURE / Size

APOLLO 180 COD. TA1C3 L 180/280 P 90 H 75 cm

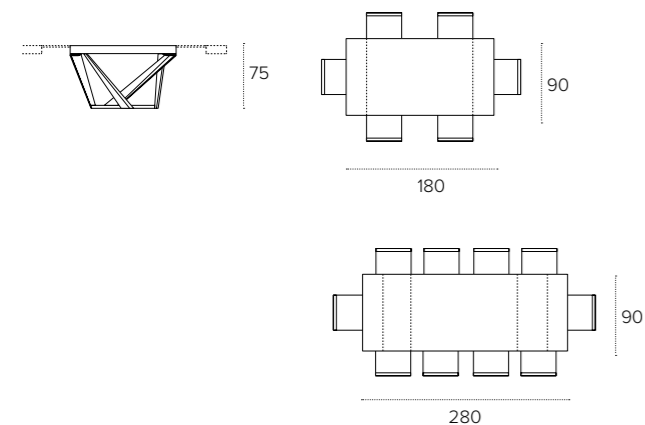

APOLLO 160 COD. TA1C4 L 160/240 P 90 H 75 cm

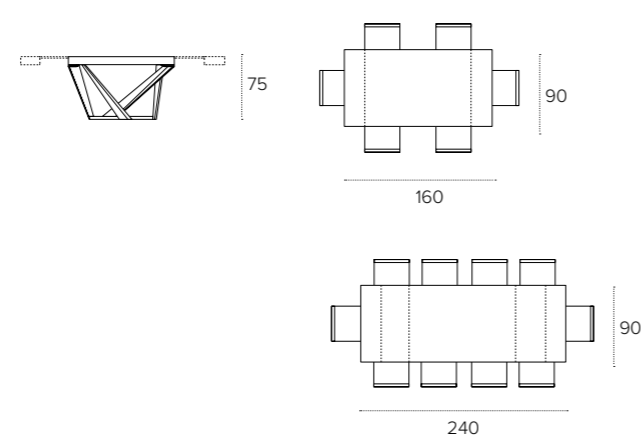

GRECALE

TAVOLO ALLUNGABILE / EXTENDABLE TABLE
COD. TA1C1 - TOP 180/270X90 cm

Tavolo allungabile in legno con gambe in metallo Grafite 0122. Piano ed allunghe laterali in laminato effetto legno Castoro 1724.

Extendable wooden table with Graphite 0122 painted metal legs. Top and side extensions in Beaver 1724 wood-effect laminate.

Table extensible en bois avec pieds en fer Graphite 0122. Plateau et allonges latérales en stratifié effet bois Castor 1724.

Mesa extensible de madera con patas en metal pintado Grafito 0122. Encimera y extensibles laterales en laminado efecto madera Castor 1724.

Sedie/Chairs/Chaises/Sillas LUGANO SE504.



GRECALE

TAVOLO ALLUNGABILE / EXTENDABLE TABLE
COD. TA1C1 - TOP 180/270X90 cm

Piano ed allunghe laterali in laminato effetto legno Castoro 1724.

Top and side extensions in Beaver 1724 wood-effect laminate.

Plateau et allonges latérales en stratifié effet bois Castor 1724.

Encimera y extensibles laterales en laminado efecto madera Castor 1724.

Sedie/Chairs/Chaises/Sillas LUGANO SE504.



GRECALE

TAVOLO ALLUNGABILE / EXTENDABLE TABLE
COD. TA1C1 - TOP 180/270X90 cm

Tavolo allungabile con gambe in metallo Terra 0139. Piano ed allunghe laterali in laminato spazzolato Argilla 1L46.

Extendable table with Earth 0139 painted metal legs. Top and side extensions in Clay 1L46 brushed laminate.
Table extensible avec pieds en fer peint Terre 0139. Plateau et allonges latérales en stratifié brossé Argile 1L46.
Mesa extensible con patas en metal pintado Tierra 0139. Encimera y extensibles laterales en laminado cepillado Arcilla 1L46.

Sedie/Chairs/Chaises/Sillas BRASILIA SE1A0.



GRECALE

TAVOLO ALLUNGABILE / EXTENDABLE TABLE
COD. TA1C1 - TOP 180/270X90 cm

Tavolo allungabile in legno con gambe in metallo Grafite 0122. Piano ed allunghe laterali in laminato spazzolato Vulcano 1L62.

Extendable wooden table with Graphite 0122 painted metal legs. Top and side extensions in Volcano 1L62 brushed laminate.

Table extensible en bois avec pieds en fer peint Graphite 0122. Plateau et allonges latérales en stratifié brossé Volcan 1L62.

Mesa extensible de madera con patas en metal pintado Grafito 0122. Encimera y extensibles laterales en laminado cepillado Volcan 1L62.

Sedie/Chairs/Chaises/Sillas DETROIT SE619.



GRECALE

TAVOLO ALLUNGABILE / EXTENDABLE TABLE
COD. TA1C1 - TOP 180/270X90 cm

Tavolo allungabile in legno con gambe in metallo Grafite 0122. Piano ed allunghe laterali in laminato spazzolato Vulcano 1L62.

Extendable wooden table with Graphite 0122 painted metal legs. Top and side extensions in Volcano 1L62 brushed laminate.

Table extensible en bois avec pieds en fer peint Graphite 0122. Plateau et allonges latérales en stratifié brossé Volcan 1L62.

Mesa extensible de madera con patas en metal pintado Grafito 0122. Encimera y extensibles laterales en laminado cepillado Volcan 1L62.

Sedie/Chairs/Chaises/Sillas DETROIT SE619.



FINITURE / Finishes

STRUTTURA / Frame
 metallo / metal



0108
 Bianco
 White



0112
 Bronzo
 Bronze



0122
 Grafite
 Graphite



0139
 Terra
 Earth



0640
 Silver Spazzolato
 Brushed Silver

PIANO / Top
 laminato effetto legno /
 wood-effect laminate



1724
 Castoro
 Beaver



1727
 Rustico
 Country



1728
 Rustico Bianco
 White Country

PIANO / Top
 laminato spazzolato /
 brushed laminate



1L46
 Argilla
 Clay



1L62
 Vulcano
 Volcano

MISURE / Size

L 180 / 280 P 90 H 75 cm

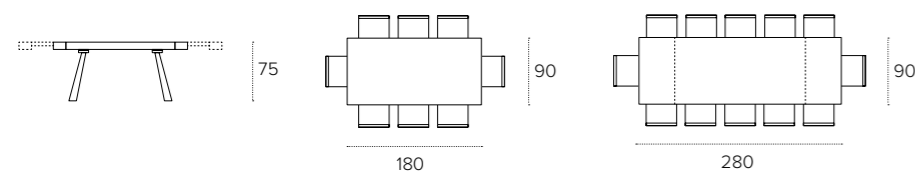

PONENTE

TAVOLO ALLUNGABILE / EXTENDABLE TABLE
COD. TA1A8 - TOP 160/240X90 cm

Tavolo allungabile con gamba in metallo verniciato Bianco 0108. Piano ed allunghe laterali in gres porcellanato effetto marmo Calacatta 3808.

Extendable table with White 0108 painted metal structure. Top and side extensions in Calacatta 3808 marble-effect porcelain gres stoneware.

Table extensible avec structure en fer peint Blanc 0108. Plateau et allonges latérales en céramique effet marbre Calacatta 3808.

Mesa extensible con pata en metal pintado Blanco 0108. Encimera y extensibles laterales en porcelanico efecto marmol Calacatta 3808.

Sedia / chair / chaise / silla VIENNA SE608.



PONENTE

TAVOLO ALLUNGABILE / EXTENDABLE TABLE
COD. TA1A8 - TOP 160/240X90 cm

Tavolo allungabile con struttura in metallo Bronzo 0112, piano ed allunghe laterali in gres porcellanato effetto marmo Sabbia 3825.

Extendable table with Bronze 0112 metal structure, top and side extensions in Sand 3825 marble-effect porcelain gres stoneware.

Table extensible avec piètement en métal peint Bronze 0112 et plateau en céramique effet marbre Sable 3825.

Mesa extensible con patas en metal pintado Bronce 0112 y encimera en porcelánico efecto marmol Arena 3825.

Sedia/Chair/Chaise/Silla MAIORCA SE190.



PONENTE

TAVOLO ALLUNGABILE / EXTENDABLE TABLE
COD. TA1A4 - TOP 180/270X90 cm

Tavolo allungabile con gamba in metallo verniciato Grafite 0122. Piano ed allunghe laterali in gres porcellanato Grafite 3521.

Extendable table with Graphite 0122 painted metal structure. Top and side extensions in Graphite 3521 porcelain gres stoneware.

Table extensible avec structure en fer peint Graphite 0122. Plateau et allonges latérales en céramique Graphite 3521.

Mesa extensible con pata en metal intado Grafito 0122. Encimera y extensibles laterales en porcelanico Grafito 3521.

Sedia / chair / chaise / silla ZURIGO SE503.



PONENTE

TAVOLO ALLUNGABILE / EXTENDABLE TABLE
COD. TA1A4 - TOP 180/270X90 cm



















Tavolo allungabile con gamba in metallo verniciato Grafite 0122. Piano ed allunghe laterali in gres porcellanato Grafite 3521.

Extendable table with Graphite 0122 painted metal structure. Top and side extensions in Graphite 3521 porcelain gres stoneware.

Table extensible avec structure en fer peint Graphite 0122. Plateau et allonges latérales en céramique Graphite 3521.

Mesa extensible con pata en metal intado Grafito 0122. Encimera y extensibles laterales en porcelanico Grafito 3521.

FINITURE / Finishes

STRUTTURA / Frame metallo / metal	 0108 Bianco White	 0112 Bronzo Bronze	 0122 Grafite Graphite	 0139 Terra Earth	 0640 Silver Spazzolato Brushed Silver
PIANO / Top gres opaco / matt stoneware	 3521 Grafite Graphite	 3808 Calacatta Calacatta	 3822 Fiordibosco	 3825 Sabbia Sand	*disponibili solamente per TA1A8 con top da 160x90 / only available for TA1A8 with 160x90 top
PIANO / Top gres lucido / glossy stoneware	 3828 Carrara Carrara	 3816 Alabastro Alabaster	 3818 Arabescato Arabesque	 3660 Emperador Emperador	
TELAIO / Top Frame metallo / metal	 0108 Bianco White	 0122 Grafite Graphite	 0108 Bianco White		
PIANO / Top vetro / glass	 2001 Trasparente Transparent	 2001 Trasparente Transparent	 2108 Extra bianco Extra white		

MISURE / Size

L 180 / 270 P 90 H 75 cm

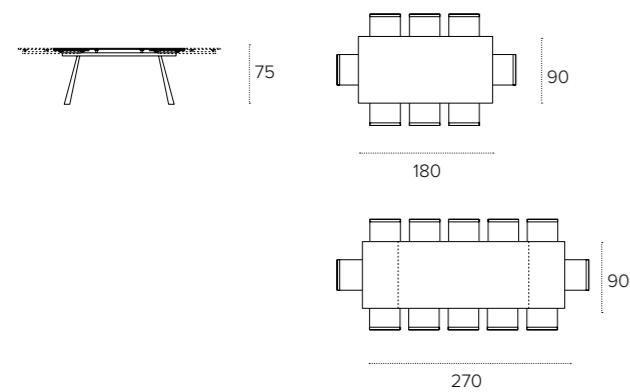

L 160 / 240 P 90 H 75 cm

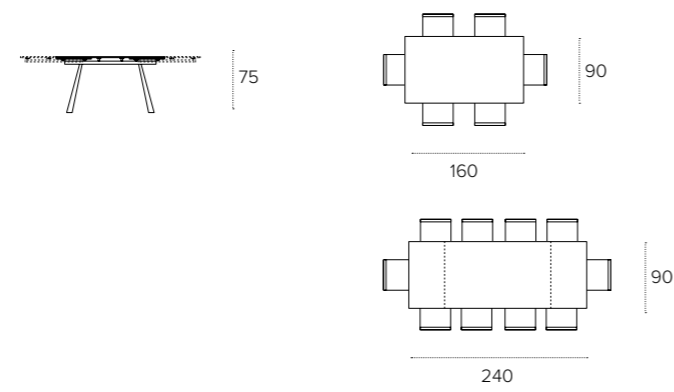

GIOVE

TAVOLO ALLUNGABILE / EXTENDABLE TABLE
COD. TA193 - TOP 180/270X90 cm

Tavolo allungabile con struttura in metallo Grafite 0122, piano ed allunghe laterali in vetro temperato Trasparente 2001.

Extendable table with Graphite 0122 metal structure, top and side extensions in Transparent 2001 tempered glass.
Table extensible avec piètement en métal peint Graphite 0122 et plateau en verre trempé Transparent 2001.
Mesa extensible con patas en metal pintado Grafito 0122 y encimera en cristal templado Transparente 2001.

Sedia/Chair/Chaise/Silla LUGANO SE504.



GIOVE

TAVOLO ALLUNGABILE / EXTENDABLE TABLE
COD. TA193 - TOP 180/270X90 cm

Tavolo allungabile con struttura in metallo Terra 0139, piano ed allunghe laterali in gres porcellanato effetto marmo Emperador 3660.

Extendable table with Earth 0139 metal structure, top and side extensions in Emperador 3660 marble-effect porcelain gres stoneware.

Table extensible avec piètement en métal peint Terre 0139 et plateau en céramique effet marbre Emperador 3660.

Mesa extensible con patas en metal pintado Tierra 0139 y encimera en porcelánico efecto marmol Emperador 3660.

Sedia/Chair/Chaise/Silla DIGIONE SE185.

FINITURE / Finishes

STRUTTURA / Frame
 metallo / metal



0108
Bianco
White



0112
Bronzo
Bronze



0122
Grafite
Graphite



0124
Ghiaccio
Ice grey



0139
Terra
Earth

PIANO / Top
 gres opaco /
 matt stoneware



3521
Grafite
Graphite



3808
Calacatta
Calacatta

PIANO / Top
 gres lucido /
 glossy stoneware



3828
Carrara
Carrara



3816
Alabastro
Alabaster



3818
Arabescato
Arabesque



3660
Emperador
Emperador

PIANO / Top
 vetro / glass



2001
Trasparente
Transparent

MISURE / Size

L 180 / 270 P 90 H 75 cm



75

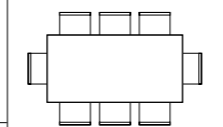

90

180

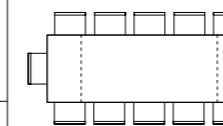

270



GIOVE

TAVOLO ALLUNGABILE / EXTENDABLE TABLE
COD. TA177 - TOP 160/240X90 cm

Tavolo allungabile con struttura in metallo verniciato
Bronzo 0112, Piano ed allunghe laterali in gres
porcellanato effetto marmo Sabbia 3825.

Extendable table with Bronze 0112 painted metal legs. Top
and side extensions in Sand 3825 marble-effect porcelain
gres stoneware.

Table extensible avec piétement en métal peint Bronze 0112
et plateau en céramique effet marbre Sable 3825.

Mesa extensible con patas en metal pintado Bronce 0112 y
encimera en porcelánico efecto marmol Arena 3825.

Sedia/Chair/Chaise/Silla MAIORCA SE190.





















GIOVE

TAVOLO ALLUNGABILE / EXTENDABLE TABLE
COD. TA177 - TOP 160/240X90 cm

Tavolo allungabile con struttura in metallo verniciato
 Grafite 0122, Piano ed allunghe laterali in gres
 porcellanato effetto marmo Fiordibosco 3822.
 Extendable table with Graphite 0122 painted metal legs.
 Top and side extensions in Fiordibosco 3822 marble-effect
 porcelain gres stoneware.
 Table extensible avec piètement en métal peint Graphite
 0122 et plateau en céramique effet marbre Fiordibosco
 3822.
 Mesa extensible con patas en metal pintado Grafito 0122 y
 encimera en porcelánico efecto marmol Fiordibosco 3822.

Sedia/Chair/Chaise/Silla SALISBURGO SE508.

FINITURE / Finishes

STRUTTURA / Frame metallo / metal	 0108 Bianco White	 0112 Bronzo Bronze	 0122 Grafite Graphite	 0124 Ghiaccio Ice grey	 0139 Terra Earth
PIANO / Top gres opaco / matt stoneware	 3521 Grafite Graphite	 3808 Calacatta Calacatta	 3822 Fiordibosco Fiordibosco	 3825 Sabbia Sand	
PIANO / Top gres lucido / glossy stoneware	 3828 Carrara Carrara	 3816 Alabastro Alabaster	 3818 Arabescato Arabesque	 3660 Emperador Emperador	
Telaio / Top frame metallo / metal	 0108 Bianco White	 0122 Grafite Graphite	 0108 Bianco White		
PIANO / Top vetro / glass	 2001 Trasparente Transparent	 2001 Trasparente Transparent	 2108 Extra bianco Extra white		

MISURE / Size

L 160 / 240 P 90 H 75 cm

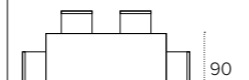
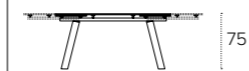

160

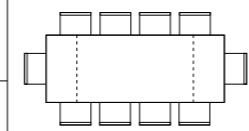

240



MARTE

TAVOLO ALLUNGABILE / EXTENDABLE TABLE
COD. TA147 - TOP 180/270X90 cm

Tavolo allungabile con gamba in metallo verniciato Grafite 0122. Piano ed allunghe laterali in gres porcellanato Grafite 3521.

Extendable table with Graphite 0122 painted metal structure. Top and side extensions in Graphite 3521 porcelain gres stoneware.

Table extensible avec structure en fer peint Graphite 0122. Plateau et allonges latérales en céramique Graphite 3521.

Mesa extensible con pata en metal intado Grafito 0122. Encimera y extensibles laterales en porcelanico Grafito 3521.

Sedia / chair / chaise / silla GINEVRA SE515.



MARTE

TAVOLO ALLUNGABILE / EXTENDABLE TABLE
COD. TA127 - TOP 160/240X90 cm

Tavolo allungabile con struttura in metallo Bronzo 0112, piano ed allunghe laterali in gres porcellanato effetto marmo Sabbia 3825.

Extendable table with Bronze 0112 metal structure, top and side extensions in Sand 3825 marble-effect porcelain gres stoneware.

Table extensible avec piètement en métal peint Bronze 0112 et plateau en céramique effet marbre Sable 3825.

Mesa extensible con patas en metal pintado Bronze 0112 y encimera en porcelánico efecto marmol Arena 3825.

Sedia/Chair/Chaise/Silla ZURIGO SE503.



MARTE

TAVOLO ALLUNGABILE / EXTENDABLE TABLE
COD. TA127

Tavolo allungabile con struttura in metallo Terra 0139, piano ed allunghe laterali in gres porcellanato effetto marmo Emperador 3660.

















Extendable table with Earth 0139 metal structure, top and side extensions in Emperador 3660 marble-effect porcelain gres stoneware.

Table extensible avec piètement en métal peint Terre 0139 et plateau en céramique effet marbre Emperador 3660.

Mesa extensible con patas en metal pintado Tierra 0139 y encimera en porcelánico efecto marmol Emperador 3660.

Sedia/Chair/Chaise/Silla DIGIONE SE185.

FINITURE / Finishes

STRUTTURA / Frame metallo / metal	 0108 Bianco White	 0112 Bronzo Bronze	 0122 Grafite Graphite	 0124 Ghiaccio Ice grey	 0139 Terra Earth
PIANO / Top gres opaco / matt stoneware	 3521 Grafite Graphite	 3808 Calacatta Calacatta			
PIANO / Top gres lucido / glossy stoneware	 3828 Carrara Carrara	 3816 Alabastro Alabaster	 3818 Arabescato Arabesque	 3660 Emperador Emperador	
Telaio / Top frame metallo / metal	 0108 Bianco White	 0122 Grafite Graphite	 0108 Bianco White		
PIANO / Top vetro / glass	 2001 Trasparente Transparent	 2001 Trasparente Transparent	 2108 Extra bianco Extra white		

MISURE / Size

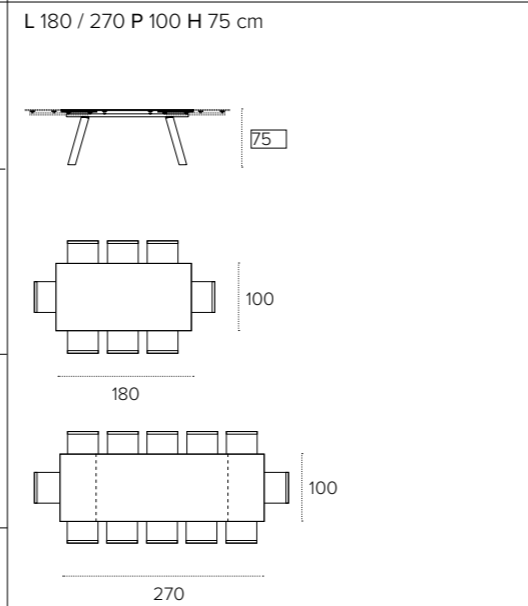

MARTE

TAVOLO ALLUNGABILE / EXTENDABLE TABLE
COD. TA147

Tavolo allungabile con gamba in metallo verniciato Grafite 0122. Piano ed allunghe laterali in vetro temperato Trasparente 2001.

Extendable table with Graphite 0122 painted metal structure. Top and side extensions in Transparent 2001 tempered glass.

Table extensible avec structure en fer peint Graphite 0122. Plateau et allonges latérales en verre trempé Tarnsaprent 2001.

Mesa extensible con pata en metal pintado Grafito 0122. Encimera y extensibles laterales en cristal templado Transparente 2001.

Sedia / chair / chaise / silla VIENNA SE608.



MARTE

TAVOLO ALLUNGABILE / EXTENDABLE TABLE
COD. TA127 - TOP 160/240X90 cm

Tavolo allungabile con gamba in metallo verniciato Bianco 0108. Piano ed allunghe laterali in vetro temperato Extra Bianco 2108.

Extendable table with White 0108 painted metal structure. Top and side extensions in Extra White 2108 tempered glass.

Table extensible avec structure en fer peint Blanc 0108. Plateau et allonges latérales en verre trempé Extra Blanc 2108.

Mesa extensible con pata en metal pintado Blanco 0108. Encimera y extensibles laterales en cristal templado Extra Blanco 2108.

Sedia / chair / chaise / silla FUTURA SE800.

FINITURE / Finishes

STRUTTURA / Frame
 metallo / metal



0108
Bianco
White



0112
Bronzo
Bronze



0122
Grafite
Graphite



0124
Ghiaccio
Ice grey



0139
Terra
Earth

PIANO / Top
 gres opaco /
 matt stoneware



3521
Grafite
Graphite



3808
Calacatta
Calacatta



3822
Fiordibosco
Fiordibosco



3825
Sabbia
Sand

PIANO / Top
 gres lucido /
 glossy stoneware



3828
Carrara
Carrara



3816
Alabastro
Alabaster



3818
Arabescato
Arabesque



3660
Emperador
Emperador

Telaio / Top frame
 metallo / metal



0108
Bianco
White



0122
Grafite
Graphite



0108
Bianco
White

PIANO / Top
 vetro / glass



2001
Trasparente
Transparent



2001
Trasparente
Transparent



2108
Extra bianco
Extra white

MISURE / Size

L 160 / 240 P 90 H 75 cm

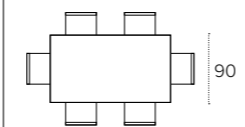

160

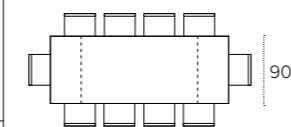

240



DEIMOS

TAVOLO ALLUNGABILE / EXTENDABLE TABLE
COD. TA190 - TOP 160/240X90 cm

Tavolo allungabile in alluminio con gamba in metallo verniciato Grafite 0122. Piano ed allunghe laterali in laminato effetto legno Rustico bianco 1728.

Extendable table with Graphite 0122 painted aluminum structure. Top and side extensions in White country 1728 synchro-texture wood-effect laminate.

Table extensible avec structure en aluminium peint Graphite 0122. Plateau et allonges latérales en stratifié effet bois à texture synchro Rustique blanc 1728.

Mesa extensible con pata en aluminio pintado Grafito 0122. Encimera y extensibles laterales en laminado textura sincronica efecto madera Rustico blanco 1728.

Sedia / chair / chaise /silla VIENNA SE608.



DEIMOS

TAVOLO ALLUNGABILE / EXTENDABLE TABLE
COD. TA190 - TOP 160/240X90 cm

Tavolo allungabile in alluminio con gamba in metallo verniciato Grafite 0122. Piano ed allunghe laterali in laminato effetto legno Rustico bianco 1728.

Extendable table with Graphite 0122 painted aluminum structure. Top and side extensions in White country 1728 synchro-texture wood-effect laminate.

Table extensible avec structure en aluminium peint Graphite 0122. Plateau et allonges latérales en stratifié effet bois à texture synchro Rustique blanc 1728.

Mesa extensible con pata en aluminio pintado Grafito 0122. Encimera y extensibles laterales en laminado textura sincronica efecto madera Rustico blanco 1728.

Sedia / chair / chaise /silla VIENNA SE608.



DEIMOS

TAVOLO ALLUNGABILE / EXTENDABLE TABLE
COD. TA190 - TOP 160/240X90 cm

Tavolo allungabile in alluminio con gamba in metallo verniciato Grafite 0122. Piano in gres porcellanato effetto marmo Arabescato 3818 con allunghe laterali interne al piano in MDF laccato.

Extendable table with Graphite 0122 painted aluminum structure. Top in Arabesque 3818 marble-effect porcelain gres stoneware and side extensions in lacquered MDF inside the top.

Table extensible avec structure en aluminium peint Graphite 0122. Plateau en céramique effet marbre Arabesque 3818 et allonges latérales en MDF laqué à l'intérieur du plateau.

Mesa extensible con pata en aluminio pintado Grafito 0122. Encimera en porcelánico efecto marmol Arabescato 3818 y extensibles laterales en MDF lacado dentro la encimera.

Sedia / chair / chaise /silla BELLINZONA SE507.



DEIMOS

TAVOLO ALLUNGABILE / EXTENDABLE TABLE
COD. TA190 - TOP 160/240X90 cm























Tavolo allungabile in alluminio con gamba in metallo verniciato Bronzo 0112. Piano ed allunghe laterali in laminato effetto legno Rustico 1727.

Extendable table with Bronze 0112 painted aluminum structure. Top and side extensions in Country 1727 synchro-texture wood-effect laminate.

Table extensible avec structure en aluminium peint Bronze 0112. Plateau et allonges latérales en stratifié effet bois à texture synchro Rustique 1727.

Mesa extensible con pata en aluminio pintado Bronce 0112. Encimera y extensibles laterales en laminado textura sincronica efecto madera Rustico 1727.

FINITURE / Finishes

STRUTTURA / Frame metallo / metal	 0108 Bianco White	 0112 Bronzo Bronze	 0122 Grafite Graphite	 0139 Terra Earth	 0124 Ghiaccio Ice Grey	 0110 Nero Black
ALLUNGHE / Extensions mdf laccato / lacquered mdf	 1208 Bianco White	 1212 Bronzo Bronze	 1221 Grafite Graphite	 1239 Terra Earth	 1224 Ghiaccio Ice Grey	
PIANO / Top gres lucido / glossy stoneware	 3828 Carrara Carrara	 3816 Alabastro Alabaster	 3818 Arabescato Arabesque	 3660 Emperador Emperador		
PIANO / Top gres opaco / matt stoneware	 3521 Grafite Graphite	 3822 Fiordibosco Fiordibosco	 3825 Sabbia Sand	 3808 Calacatta Calacatta		
PIANO / Top vetro temperato / tempered glass	 2108 Extra bianco Extra white					
PIANO E ALLUNGHE / Top and extensions laminato effetto legno / wood-effect laminate	 1724 Castoro Beaver	 1727 Rustico Country	 1728 Rustico bianco White country			

MISURE / Size

L 160/240 P 90 H 75 cm

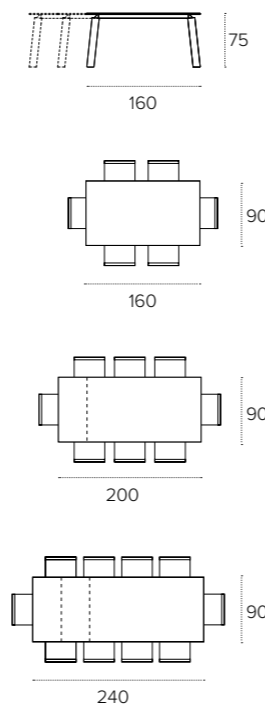

DEIMOS

TAVOLO ALLUNGABILE / EXTENDABLE TABLE
COD. TA191 - TOP 130/200X85 cm

Tavolo allungabile con basamento in metallo Grafite 0122 e piano in gres porcellanato effetto marmo Fiordibosco 3822.

Extendable table with Graphite 0122 metal basement and Fiordibosco 3822 marble-effect stoneware top.

Table extensible avec piètement en métal Graphite 0122 et plateau en céramique effet marbre Fiordibosco 3822.

Mesa extensible con base en metal Grafito 0122 y encimera en porcelánico efecto marmol Fiordibosco 3822.

Sedia / Chair / Chaise / Silla CORDOBA SE804.



DEIMOS

TAVOLO ALLUNGABILE / EXTENDABLE TABLE
COD. TA191 - TOP 130/200X85 cm

Tavolo allungabile con struttura in metallo verniciato Terra 0139. Piano in gres porcellanato effetto marmo Alabastro 3816 e allunghe laterali in MDF laccato Terra 1239.























Extendable table with Earth 0139 painted metal frame. Top in Alabaster 3816 marble-effect porcelain stoneware and side extensions in Earth 1239 lacquered MDF.

Table extensible avec structure en fer peint Terre 0139. Plateau en céramique effet marbre Albatre 3816 et allonges latérales en MDF laqué Terre 1239.

Mesa extensible con pata en metal pintado Tierra 0139. Encimera en porcelánico efecto marmol Alabastro 3816 y extensibles laterales en MDF lacado Tierra 1239.

Sedia / chair / chaise / silla NIZZA SE603.

FINITURE / Finishes

STRUTTURA / Frame metallo / metal	 0108 Bianco White	 0112 Bronzo Bronze	 0122 Grafite Graphite	 0139 Terra Earth	 0124 Ghiaccio Ice Grey	 0110 Nero Black
ALLUNGHE / Extensions mdf laccato / lacquered mdf	 1208 Bianco White	 1212 Bronzo Bronze	 1221 Grafite Graphite	 1239 Terra Earth	 1224 Ghiaccio Ice Grey	
PIANO / Top gres lucido / glossy stoneware	 3828 Carrara Carrara	 3816 Alabastro Alabaster	 3818 Arabescato Arabesque	 3660 Emperador Emperador		
PIANO / Top gres opaco / matt stoneware	 3521 Grafite Graphite	 3822 Fiordibosco Fiordibosco	 3825 Sabbia Sand	 3808 Calacatta Calacatta		
PIANO / Top vetro temperato / tempered glass	 2108 Extra bianco Extra white					
PIANO E ALLUNGHE / Top and extensions laminato effetto legno / wood-effect laminate	 1724 Castoro Beaver	 1727 Rustico Country	 1728 Rustico bianco White country			

MISURE / Size

L 130 / 165 / 200 P 85 H 75 cm

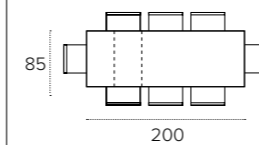
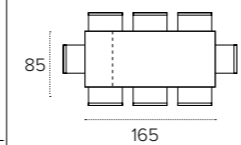
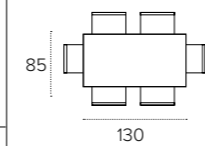
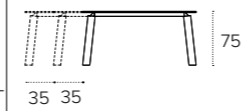

DEIMOS

TAVOLO ALLUNGABILE / EXTENDABLE TABLE
COD. TA1B7 - TOP 110/170X80 cm

Tavolo allungabile con struttura in metallo verniciato Grafite 0122. Piano in gres porcellanato Grafite 3521 e allunghe laterali in MDF laccato Grafite 1221.

Extendable table with Graphite 0122 painted metal frame. Top in Graphite 3521 porcelain gres stoneware and side extensions in Graphite 1221 lacquered MDF.

Table extensible avec structure en fer peint Graphite 0122. Plateau en céramique Graphite 3521 et allonges latérales en MDF laqué Graphite 1221.

Mesa extensible con pata en metal pintado Grafito 0122.

Encimera en porcelanico Grafito 3521 y extensibles laterales en MDF lacado Grafito 1221.

Sedia / chair / chaise / silla ALMERIA SE806.



DEIMOS

















TAVOLO ALLUNGABILE / EXTENDABLE TABLE
COD. TA1B7 - TOP 110/170X80 cm

Tavolo allungabile con basamento in metallo Bianco 0108 e piano in gres porcellanato effetto marmo Carrara 3828.

Extendable table with White 0108 metal basement and Carrara 3828 marble-effect stoneware top.
 Table extensible avec piètement en métal Blanc 0108 et plateau en céramique effet marbre Carrare 3828.
 Mesa extensible con base en metal Blanco 0108 y encimera en porcelánico efecto marmol Carrara 3828.

Sedia / Chair / Chaise / Silla SIVIGLIA SE807.

FINITURE / Finishes

STRUTTURA / Frame metallo / metal	 0108 Bianco White	 0112 Bronzo Bronze	 0122 Grafite Graphite	 0124 Ghiaccio Ice Grey
ALLUNGHE / Extensions mdf laccato / lacquered mdf	 1208 Bianco White	 1212 Bronzo Bronze	 1221 Grafite Graphite	 1224 Ghiaccio Ice Grey
PIANO / Top gres lucido / glossy stoneware	 3828 Carrara Carrara	 3818 Arabescato Arabesque		
PIANO / Top gres opaco / matt stoneware	 3521 Grafite Graphite	 3822 Fiordibosco Fiordibosco	 3825 Sabbia Sand	 3808 Calacatta Calacatta
PIANO / Top vetro temperato / tempered glass	 2108 Extra bianco Extra white			
PIANO E ALLUNGHE / Top and extensions laminato effetto legno / wood-effect laminate	 1724 Castoro Beaver	 1727 Rustico Country	 1728 Rustico bianco White country	

MISURE / Size

L 110/170 P 80 H 75 cm

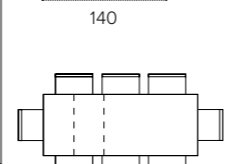
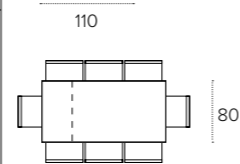
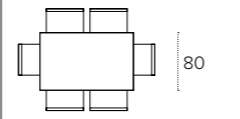
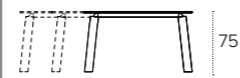

170



SATURNO

TAVOLO ALLUNGABILE / EXTENDABLE TABLE
COD. TA192 - TOP 160/240X90 cm

Tavolo allungabile con basamento in metallo Bianco 0108 e piano in gres porcellanato effetto marmo Fiordibosco 3822.

Extendable table with White 0108 metal basement and Fiordibosco 3822 marble-effect stoneware top.

Table extensible avec piètement en métal Blanc 0108 et plateau en céramique effet marbre Fiordibosco 3822.

Mesa extensible con base en metal Blanco 0108 y encimera en porcelánico efecto marmol Fiordibosco 3822.

Sedia / Chair / Chaise / Silla CORDOBA SE804.



SATURNO

TAVOLO ALLUNGABILE / EXTENDABLE TABLE
COD. TA192 - TOP 160/240X90 cm

Tavolo allungabile in alluminio con gamba in metallo verniciato Grafite 0122. Piano ed allunghe laterali in laminato a poro registro effetto legno Rustico 1727.

Extendable table with Graphite 0122 aluminum structure. Top and side extensions in Country 1727 wood-effect synchro-texture laminate.

Table extensible avec piètement en alluminium Graphite 0122 et plateau en stratifié à texture synchro effet bois Rustique 1727.

Mesa extensible con base en aluminio Grafito 0122 y encimera en laminado textura sincronica efecto madera Rustico 1727.

Sedia / Chair / Chaise / Silla BERLINO SE506.



SATURNO

TAVOLO ALLUNGABILE / EXTENDABLE TABLE
COD. TA192 - TOP 160/240X90 cm

Tavolo allungabile con struttura in alluminio verniciato Ghiaccio 0124.























Piano in gres porcellanato effetto marmo Arabescato 3818 e allunghe laterali in MDF laccato interne al piano.
 Extendable table with Ice grey 0124 painted aluminum structure. Top in Arabesque 3818 marble-effect stoneware and side extensions in painted MDF inside the top.

Table extensible avec structure n aluminium peint Gris glace 0124. Plateau en céramique effet marbre Arabesque 3818 et allonges latérales en MDF laqué à l'intérieur du plateau.

Mesa con estructura en aluminio pintado Gris hielo 0124. Encimera en porcelánico efecto marmol Arabescato 3818 y extensibles laterales en MDF lacado dentro de la encimera.

Sedia / chair / chaise / silla ALMERIA SE806.

FINITURE / Finishes

STRUTTURA / Frame metallo / metal	 0108 Bianco White	 0112 Bronzo Bronze	 0122 Grafite Graphite	 0139 Terra Earth	 0124 Ghiaccio Ice Grey	 0110 Nero Black
ALLUNGHE / Extensions mdf laccato / lacquered mdf	 1208 Bianco White	 1212 Bronzo Bronze	 1221 Grafite Graphite	 1239 Terra Earth	 1224 Ghiaccio Ice Grey	
PIANO / Top gres lucido / glossy stoneware	 3828 Carrara Carrara	 3816 Alabastro Alabaster	 3818 Arabescato Arabesque	 3660 Emperador Emperador		
PIANO / Top gres opaco / matt stoneware	 3521 Grafite Graphite	 3822 Fiordibosco Fiordibosco	 3825 Sabbia Sand	 3808 Calacatta Calacatta		
PIANO / Top vetro temperato / tempered glass	 2108 Extra bianco Extra white					
PIANO E ALLUNGHE / Top and extensions laminato effetto legno / wood-effect laminate	 1724 Castoro Beaver	 1727 Rustico Country	 1728 Rustico bianco White country			

MISURE / Size

L 160 / 200 / 240 P 90 H 75 cm

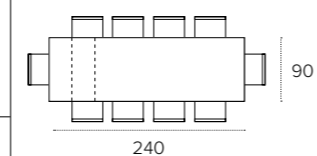
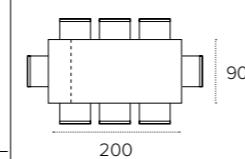
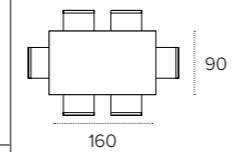
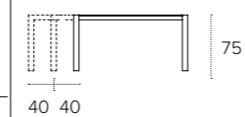

SATURNO

TAVOLO ALLUNGABILE / EXTENDABLE TABLE
COD. TA188 - TOP 130/200X85 cm

Tavolo allungabile in alluminio con gamba in metallo verniciato Grafite 0122. Piano ed allunghe laterali in laminato a poro registro effetto legno Castoro 1724.
Extendable table with Graphite 0122 aluminum structure. Top and side extensions in Beaver 1724 wood-effect synchro-texture laminate.
Table extensible avec piètement en alluminium Graphite 0122 et plateau en stratifié à texture synchro effet bois Castor 1724.
Mesa extensible con base en aluminio Grafito 0122 y encimera en laminado textura sincronica efecto madera Castor 1724.

Sedia / Chair / Chaise / Silla VALENCIA SE193.



SATURNO























TAVOLO ALLUNGABILE / EXTENDABLE TABLE
COD. TA188 - TOP 130/200X85 cm

**Tavolo allungabile in alluminio con gamba in metallo
 Grafite 0122 e piano in gres porcellanato effetto marmo
 Calacatta 3808.**

Extendable table with Graphite 0122 aluminum structure and
 Calacatta 3808 marble-effect porcelain gres stoneware top.
 Table extensible avec piètement en aluminium peint Graphite
 0122 et plateau en céramique effet marbre Calacatta 3808.
 Mesa extensible con base en aluminio pintado Grafito 0122 y
 encimera en porcelánico efecto marmol Calacatta 3808.

Sedia / Chair / Chaise / Silla BERLINO SE506.

FINITURE / Finishes

STRUTTURA / Frame metallo / metal	 0108 Bianco White	 0112 Bronzo Bronze	 0122 Grafite Graphite	 0139 Terra Earth	 0124 Ghiaccio Ice Grey	 0110 Nero Black
ALLUNGHE / Extensions mdf laccato / lacquered mdf	 1208 Bianco White	 1212 Bronzo Bronze	 1221 Grafite Graphite	 1239 Terra Earth	 1224 Ghiaccio Ice Grey	
PIANO / Top gres lucido / glossy stoneware	 3828 Carrara Carrara	 3816 Alabastro Alabaster	 3818 Arabescato Arabesque	 3660 Emperador Emperador		
PIANO / Top gres opaco / matt stoneware	 3521 Grafite Graphite	 3822 Fiordibosco Fiordibosco	 3825 Sabbia Sand	 3808 Calacatta Calacatta		
PIANO / Top vetro temperato / tempered glass	 2108 Extra bianco Extra white					
PIANO E ALLUNGHE / Top and extensions laminato effetto legno / wood-effect laminate	 1724 Castoro Beaver	 1727 Rustico Country	 1728 Rustico bianco White country			

MISURE / Size

L 130 / 165 / 200 P 85 H 75 cm

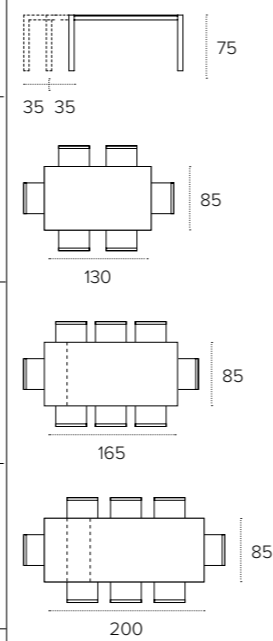

SATURNO

TAVOLO ALLUNGABILE / EXTENDABLE TABLE
COD. TA1B2 - TOP 110/170X80 cm

Tavolo allungabile in alluminio con gamba in metallo verniciato Bianco 0108. Piano in gres porcellanato effetto marmo Carrara 3828. Allunghe in MDF laccato Bianco 1208.
Extendable table with White 0108 painted aluminium frame. Top in Carrara 3828 marble-effect porcelain gres stoneware. Side extensions in White 1208 lacquered MDF.
Table extensible avec pieds et coulisses en aluminium peint Blanc 0108. Plateau en céramique effet marbre Carrara 3828. Allonges latérales en MDF laqué Blanc 1208.
Mesa extensible con patas y bastidor en aluminio pintado Blanco 0108. Encimera en gres porcelánico efecto marmol Carrara 3828. Extensibles laterales en MDF lacado Blanco 1208.

Sedia / Chair / Chaise / Silla NIZZA SE603.



SATURNO

TAVOLO ALLUNGABILE / EXTENDABLE TABLE
COD. TA1B2 - TOP 110/170X80 cm

Tavolo allungabile in alluminio con gamba in metallo verniciato Grafite 0122. Piano in gres porcellanato effetto marmo Arabescato 3818. Allunghe interne in MDF laccato.

Extendable aluminium table with Graphite 0122 painted metal frame. Top in Arabesque 3818 marble-effect porcelain gres stoneware. Internal extensions in lacquered MDF.





















Table extensible en avec pieds et coulisses en aluminium peint Graphite 0122. Plateau en céramique

effet marbre Arabesque 3818. Allonges en MDF laqué dans la structure du plateau.

Mesa extensible con patas y bastidor en aluminio pintado Grafito 0122. Encimera en gres porcelánico efecto marmol Arabescato 3818. Extensibles en MDF lacado guardados en la encimera.

Sedia / Chair / Chaise / Silla CORDOBA SE804.

FINITURE / Finishes

STRUTTURA / Frame metallo / metal	 0108 Bianco White	 0112 Bronzo Bronze	 0122 Grafite Graphite	 0124 Ghiaccio Ice Grey
ALLUNGHE / Extensions mdf laccato / lacquered mdf	 1208 Bianco White	 1212 Bronzo Bronze	 1221 Grafite Graphite	 1224 Ghiaccio Ice Grey
PIANO / Top gres lucido / glossy stoneware	 3828 Carrara Carrara	 3816 Alabastro Alabaster	 3818 Arabescato Arabesque	 3660 Emperador Emperador
PIANO / Top gres opaco / matt stoneware	 3521 Grafite Graphite	 3822 Fiordibosco Fiordibosco	 3825 Sabbia Sand	 3808 Calacatta Calacatta
PIANO / Top vetro temperato / tempered glass	 2108 Extra bianco Extra white			
PIANO E ALLUNGHE / Top and extensions laminato effetto legno / wood-effect laminate	 1724 Castoro Beaver	 1727 Rustico Country	 1728 Rustico bianco White country	

MISURE / Size

L 110/170 P 80 H 75 cm

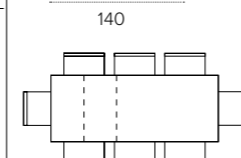
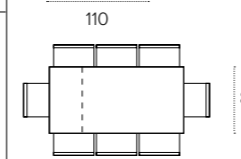
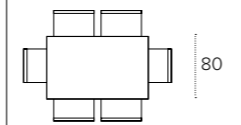
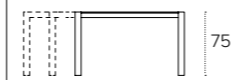

ENEA

TAVOLO ALLUNGABILE / EXTENDABLE TABLE
COD. TA1D9 - TOP 130/180X90 cm

Tavolo allungabile con gamba in metallo verniciato
Grafite 0122.

Piano e allunga laterale in gres porcellanato effetto
marmo Carrara 3828 con vena a correre su tutta la
lunghezza del top.

Extendable table with Graphite 0122 painted metal
frame. Top and side extension in Carrara 3828 marble-
effect porcelain stoneware, with marble vein running
on the whole top.

Table extensible avec structure en métal peint
Graphite 0122. Plateau et allonge latérale en
céramique effet marbre Carrara 3828, avec meme
dessin du marbre sur toute la longueur du plateau.
Mesa extensible con patasen metal pintado Grafito
0122. Encimera y extensible lateral en porcelánico
efecto marmol Carrara 3828, con misma beta de
marmol en toda la longitud de la encimera.

Sedie/Chairs/Chaises/Sillas MALAGA SE195.



ENEA

TAVOLO ALLUNGABILE / EXTENDABLE TABLE
COD. TA1D9 - TOP 130/180X90 cm

Tavolo allungabile con gamba in metallo verniciato Ghiaccio 0124.

Piano e allunga laterale in gres porcellanato effetto marmo Arabescato 3818 con vena a correre su tutta la lunghezza del top allungato.

Extendable table with Ice grey 0124 painted metal frame. Top and side extension in Arabesque 3818 marble-effect porcelain stoneware, with marble vein running on the whole top.

Table extensible avec structure en métal peint Gris glace 0124. Plateau et allonge latérale en céramique effet marbre Arabesque 3818, avec même dessin du marbre sur toute la longueur du plateau.

Mesa extensible con patas en metal pintado Gris hielo 0124. Encimera y extensible lateral en porcelánico efecto marmol Arabescato 3818, con misma beta de marmol en toda la longitud de la encimera.

Sedie/Chairs/Chaises/Sillas BRASILIA SE1A0.



ENEA

TAVOLO ALLUNGABILE / EXTENDABLE TABLE
COD. TA1D9 - TOP 130/180X90 cm

Tavolo allungabile con gamba in metallo verniciato Ghiaccio 0124.

Piano e allunga laterale in gres porcellanato effetto marmo Arabescato 3818 con vena a correre su tutta la lunghezza del top allungato.

Extendable table with Ice grey 0124 painted metal frame. Top and side extension in Arabesque 3818 marble-effect porcelain stoneware, with marble vein running on the whole top.

Table extensible avec structure en métal peint Gris glace 0124. Plateau et allonge latérale en céramique effet marbre Arabesque 3818, avec meme dessin du marbre sur toute la longueur du plateau.

Mesa extensible con patas en metal pintado Gris hielo 0124. Encimera y extensible lateral en porcelánico efecto marmol Arabescato 3818, con misma beta de marmol en toda la longitud de la encimera.

Sedie/Chairs/Chaises/Sillas BRASILIA SE1A0.

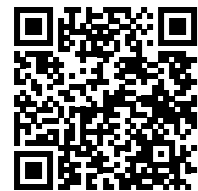

SCOPRI IL SISTEMA DI APERTURA!
 DISCOVER THE OPENING SYSTEM!
 DÉCOUVREZ LE SYSTÈME D'OUVERTURE!
 ¡DESCUBRE EL SISTEMA DE APERTURA

FINITURE / Finishes

STRUTTURA / Frame
 metallo / metal



0108
 Bianco
 White



0112
 Bronzo
 Bronze



0122
 Grafite
 Graphite



0139
 Terra
 Earth

PIANO / Top
 gres opaco /
 matt stoneware



3808
 Calacatta
 Calacatta

PIANO / Top
 gres lucido /
 glossy stoneware



3828
 Carrara
 Carrara



3816
 Alabastro
 Alabaster



3818
 Arabescato
 Arabesque



3660
 Emperador
 Emperador

MISURE / Size

L 130 / 180 P 90 H 75 cm

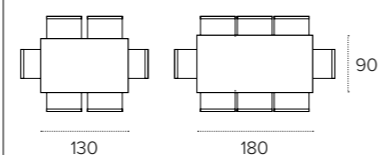
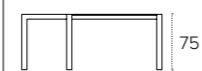

OCEANO

TAVOLO ALLUNGABILE / EXTENDABLE TABLE
COD. TA1D0 - TOP 140/200X85 cm

Tavolo allungabile con basamento in metallo Grafite 0122 e piano in gres porcellanato effetto marmo Arabescato 3818.

Extendable table with Graphite 0122 metal basement and Arabesque 3818 marble-effect stoneware top.
Table extensible avec piètement en métal Graphite 0122 et plateau en céramique effet marbre Arabesque 3818.
Mesa extensible con base en metal Grafito 0122 y encimera en porcelánico efecto marmol Arabescato 3818.

Sedia / Chair / Chaise / Silla GLAMOUR NEW SE199.



OCEANO

TAVOLO ALLUNGABILE / EXTENDABLE TABLE
COD. TA1D0 - TOP 140/200X85 cm

Tavolo allungabile con basamento in metallo Bianco 0108 e piano in gres porcellanato effetto marmo Carrara 3828.

Extendable table with White 0108 metal basement and Carrara 3828 marble-effect stoneware top.

Table extensible avec piétement en métal Blanc 0108 et plateau en céramique effet marbre Carrare 3828.

Mesa extensible con base en metal Blanco 0108 y encimera en porcelánico efecto marmol Carrara 3828.

Sedia / Chair / Chaise / Silla MAIORCA SE190.



OCEANO

TAVOLO ALLUNGABILE / EXTENDABLE TABLE
COD. TA1D0 - TOP 140/200X85 cm

Tavolo allungabile con basamento in metallo Bianco 0108 e piano in gres porcellanato effetto marmo Carrara 3828.

Extendable table with White 0108 metal basement and Carrara 3828 marble-effect stoneware top.

Table extensible avec piètement en métal Blanc 0108 et plateau en céramique effet marbre Carrare 3828.

Mesa extensible con base en metal Blanco 0108 y encimera en porcelánico efecto marmol Carrara 3828.

Sedia / Chair / Chaise / Silla MAIORCA SE190.



FINITURE / Finishes

STRUTTURA / Frame metallo / metal	0108 Bianco White	0108 Bianco White	0122 Grafite Graphite	0112 Bronzo Bronze
PIANO / Top gres opaco / matt stoneware				
PIANO / Top gres lucido / glossy stoneware				

MISURE / Size

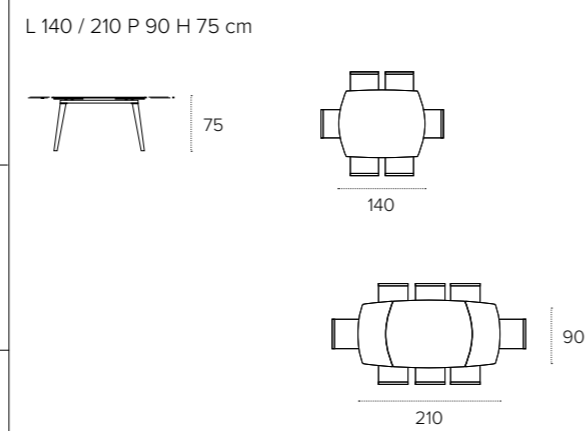

BIBLOS

TAVOLO ALLUNGABILE / EXTENDABLE TABLE
COD. TA1D4 - TOP 130/200X85 cm

Tavolo allungabile con basamento in metallo Bianco 0108 e piano in gres porcellanato effetto marmo Carrara 3828.

Extendable table with White 0108 metal basement and Carrara 3828 marble-effect porcelain gres stoneware top.

Table extensible avec piètement en métal Blanc 0108 et plateau en céramique effet marbre Carrare 3828.

Mesa extensible con base en metal Blanco 0108 y encimera en porcelánico efecto marmol Carrara 3828.

Sedia / Chair / Chaise / Silla LOCARNO SE524.



BIBLOS

TAVOLO ALLUNGABILE / EXTENDABLE TABLE
COD. TA1D4 - TOP 130/200X85 cm

Tavolo allungabile con basamento in metallo Grafite 0122 e piano in gres porcellanato effetto marmo Arabescato 3818.

Extendable table with Graphite 0122 metal basement and Arabesque 3818 marble-effect stoneware top.
Table extensible avec piètement en métal Graphite 0122 et plateau en céramique effet marbre Arabesque 3818.
Mesa extensible con base en metal Grafito 0122 y encimera en porcelánico efecto marmol Arabescato 3818.

Sedia / Chair / Chaise / Silla MALAGA SE195.



BIBLOS

TAVOLO ALLUNGABILE / EXTENDABLE TABLE
COD. TA1D4 - TOP 130/200X85 cm

Tavolo allungabile con basamento in metallo Grafite 0122 e piano in gres porcellanato effetto marmo Arabescato 3818.

Extendable table with Graphite 0122 metal basement and Arabesque 3818 marble-effect stoneware top.
 Table extensible avec piètement en métal Graphite 0122 et plateau en céramique effet marbre Arabesque 3818.
 Mesa extensible con base en metal Grafito 0122 y encimera en porcelánico efecto marmol Arabescato 3818.

Sedia / Chair / Chaise / Silla MALAGA SE195.



FINITURE / Finishes

STRUTTURA / Frame
 metallo / metal



0108
 Bianco
 White



0112
 Bronzo
 Bronze



0122
 Grafite
 Graphite

PIANO / Top
 gres opaco /
 matt stoneware



3822
 Fiordibosco
 Fiordibosco



3825
 Sabbia
 Sand



3808
 Calacatta
 Calacatta

PIANO / Top
 gres lucido /
 glossy stoneware



3828
 Carrara
 Carrara



3818
 Arabescato
 Arabesque

MISURE / Size

L 130 / 200 P 85 H 75 cm

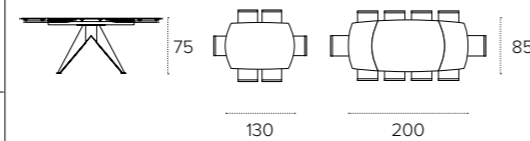

AURIGA

TAVOLO ALLUNGABILE / EXTENDABLE TABLE
COD.TA114 - TOP 140/200X90 cm

Tavolo allungabile con basamento in metallo Ghiaccio 0124. Piano e allunga laterale in gres porcellanato effetto marmo Arabescato 3818.

Extendable table with Ice grey 0124 metal basement. Top and side extension in Arabesque 3818 marble-effect porcelain gres stoneware.

Table extensible avec piètement en fer peint Gris glace 0124. Plateau et allonge latérale en céramique effet marbre Arabesque 3818.

Mesa extensible con base en metal pintado Gris hielo 0124. Encimera y extensible lateral en porcelanico efecto marmol Arabescato 3818.

Sedia / Chair / Chaise / Silla ZARA SE171.



AURIGA

TAVOLO ALLUNGABILE / EXTENDABLE TABLE
COD.TA114 - TOP 140/200X90 cm

Tavolo allungabile con basamento in metallo Bianco 0108. Piano e allunga laterale in gres porcellanato effetto marmo Carrara 3828.





Extendable table with White 0108 metal basement. Top and side extension in Carrara 3828 marble-effect porcelain gres stoneware.

Table extensible avec piètement en fer peint Blanc 0108. Plateau et allonge latérale en céramique effet marbre Carrare 3828.

Mesa extensible con base en metal pintado Blanco 0108. Encimera y extensible lateral en porcelanico efecto marmol Carrara 3828.

Sedia / Chair / Chaise / Silla NON DISPONIBILE / NOT AVAILABLE

FINITURE / Finishes

STRUTTURA / Frame metallo / metal	 0108 Bianco White	 0122 Grafite Graphite	 0124 Ghiaccio Ice Grey
PIANO / Top gres opaco / matt stoneware	 3521 Grafite Graphite		
PIANO / Top gres lucido / glossy stoneware	 3828 Carrara Carrara	 3818 Arabescato Arabesque	
PIANO / Top vetro / glass	 2108 Extra bianco Extra white		

MISURE / Size

L 140 / 200 P 90 H 75 cm

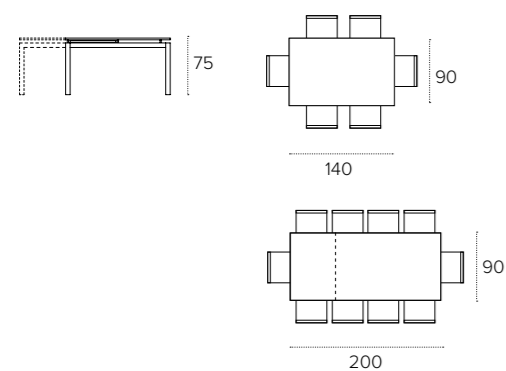

L 110 / 160 P 80 H 75 cm

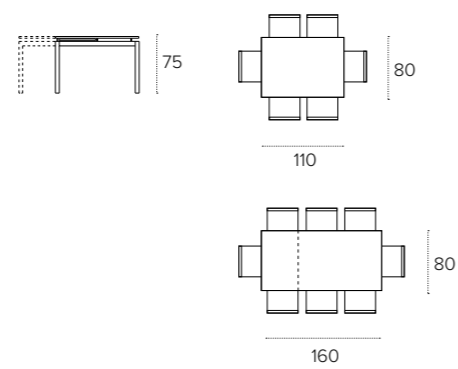

PERIGEO

TAVOLO ALLUNGABILE / EXTENDABLE TABLE
COD. TA161 - TOP 115/160X80 cm

Tavolo allungabile con struttura in metallo verniciato Bianco 0108, piano in laminato effetto legno Rustico 1727 ed allunga laterale in MDF laccato Bianco 1208 in tinta con la struttura.

Extendable table with White 0108 painted metal frame. Top in Country 1727 wood-effect laminate and side extension in White 1208 lacquered MDF matching the frame colour.

Table extensible avec structure en fer peint Blanc 0108. Plateau en stratifié effet bois Rustique 1727 et allonge latérale en MDF laqué Blanc 1208 à jeu avec la structure.

Mesa extensible con estructura en metal pintado Blanco 0108. Encimera en laminado efecto madera Rustico 1727 y extensible lateral en MDF lacado Blanco 1208 a juego con la estructura.

Sedia / chair / chaise / silla NIZZA SE603.



PERIGEO

TAVOLO ALLUNGABILE / EXTENDABLE TABLE
COD. TA161 - TOP 115/160X80 cm

Tavolo allungabile con struttura in metallo verniciato Grafite 0122. Piano in gres porcellanato Grafite 3521 ed allunga laterale in MDF laccato Grafite 1221 in tinta con la struttura.

Extendable table with Graphite 0122 painted metal frame. Top in Graphite 3521 porcelain gres stoneware and side extension in Graphite 1221 lacquered MDF matching the frame colour.

Table extensible avec structure en fer peint Graphite 3521. Plateau en céramique Graphite 3521 et allonge latérale en MDF laqué Graphite 1221 à jeu avec la structure.

Mesa extensible con estructura en metal pintado Grafito 0122. Encimera en porcelánico Grafito 3521 y extensible lateral en MDF lacado Grafito 1221 a juego con la estructura.

Sedia / chair / chaise / silla NIZZA SE603.



PERIGEO

TAVOLO ALLUNGABILE / EXTENDABLE TABLE
COD. TA159 - TOP 85/130X80 cm

Tavolo allungabile con struttura in metallo verniciato Bianco 0108, piano in laminato effetto legno Rustico bianco 1728 ed allunga laterale in MDF laccato Bianco 1208 in tinta con la struttura.

Extendable table with White 0108 painted metal frame. Top in Country white 1728 wood-effect laminate and side extension in White 1208 lacquered MDF matching the frame colour.

Table extensible avec structure en fer peint Blanc 0108. Plateau en stratifié effet bois Rustique blanc 1728 et allonge latérale en MDF laqué Blanc 1208 à jeu avec la structure.

Mesa extensible con estructura en metal pintado Blanco 0108. Encimera en laminado efecto madera Rustico blanco 1728 y extensible lateral en MDF lacado Blanco 1208 a juego con la estructura.

Sedia / chair / chaise / silla ALMERIA SE806.



PERIGEO

TAVOLO ALLUNGABILE / EXTENDABLE TABLE
COD. TA159 - TOP 85/130X80 cm

Tavolo allungabile con struttura in metallo verniciato Bianco 0108, piano in laminato effetto legno Rustico bianco 1728 ed allunga laterale in MDF laccato Bianco 1208 in tinta con la struttura.

Extendable table with White 0108 painted metal frame. Top in Country white 1728 wood-effect laminate and side extension in White 1208 lacquered MDF matching the frame colour.

Table extensible avec structure en fer peint Blanc 0108. Plateau en stratifié effet bois Rustique blanc 1728 et allonge latérale en MDF laqué Blanc 1208 à jeu avec la structure.

Mesa extensible con estructura en metal pintado Blanco 0108. Encimera en laminado efecto madera Rustico blanco 1728 y extensible lateral en MDF lacado Blanco 1208 a juego con la estructura.

Sedia / chair / chaise / silla ALMERIA SE806.

FINITURE / Finishes

STRUTTURA / Frame
 metallo / metal



0108
 Bianco
 White



0112
 Bronzo
 Bronze



0122
 Grafite
 Graphite

PIANO / Top
 gres opaco /
 matt stoneware



3521
 Grafite
 Graphite



3825
 Sabbia
 Sand



3808
 Calacatta
 Calacatta

PIANO / Top
 gres lucido /
 glossy stoneware



3828
 Carrara
 Carrara

PIANO / Top
 laminato effetto legno /
 wood-effect laminate



1727
 Rustico
 Country



1724
 Castoro
 Beaver



1728
 Rustico bianco
 White country

MISURE / Size

L 115 / 160 P 80 H 75 cm

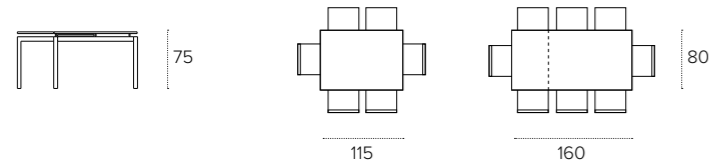

L 85 / 130 P 80 H 75 cm

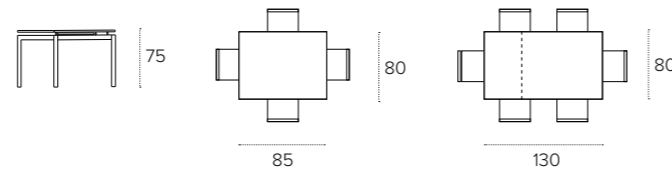

TUCANO

TAVOLO ALLUNGABILE / EXTENDABLE TABLE

TUCANO 115 COD. TP153

TUCANO 85 COD. TP152

Tavolo fisso con struttura in metallo verniciato Argento 0140 e piano in laminato effetto legno Rustico bianco 1728.

Non-extendable table with Silver 0140 painted metal frame and Country white 1728 wood-effect laminate top.

Table fixe avec structure en fer peint Argent 0140 et plateau en stratifié effet bois Rustique blanc 1728.

Mesa fija con estructura en metal pintado Plata 0140 y encimera en laminado efecto madera Rustico blanco 1728.

Sedia / Chair / Chaise / Silla SALVADOR SE 526.



FINITURE / Finishes

STRUTTURA / Frame
metallo / metal



0140
Argento
Silver

STRUTTURA / Frame
laminato / laminate



1727
Rustico
Country



1724
Castoro
Beaver



1728
Rustico bianco
White country

MISURE / Size

L 115 P 80 H 76 cm

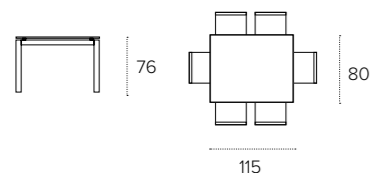

L 85 P 80 H 76 cm

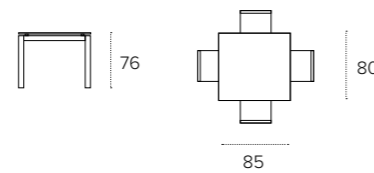

CRONOS

TAVOLO ALLUNGABILE / EXTENDABLE TABLE
COD. TA1B0 - TOP 130/200 X 130 cm

Tavolo allungabile con struttura in metallo verniciato Grafite 0122. Piano rotondo e allunga centrale in gres porcellanato Grafite 3521.

Extendable table with Graphite 0122 painted metal frame. Round top and central extension in Graphite 3521 porcelain gres stoneware.

Table extensible avec structure en fer peint Graphite 3521. Plateau rond et allonge centrale en céramique Graphite 3521.

Mesa extensible con estructura en metal pintado Grafito 0122. Encimera redonda y extensible central en porcelánico Grafito 3521.

Sedia / chair / chaise / silla ZURIGO SE503.



CRONOS

TAVOLO ALLUNGABILE / EXTENDABLE TABLE
COD. TA1B0 - TOP 130/200 X 130 cm

Tavolo allungabile con struttura in metallo verniciato Grafite 0122. Piano rotondo e allunga centrale in gres porcellanato Grafite 3521.

Extendable table with Graphite 0122 painted metal frame. Round top and central extension in Graphite 3521 porcelain gres stoneware.

Table extensible avec structure en fer peint Graphite 3521. Plateau rond et allonge centrale en céramique Graphite 3521.

Mesa extensible con estructura en metal pintado Grafito 0122. Encimera redonda y extensible central en porcelánico Grafito 3521.

Sedia / chair / chaise / silla ZURIGO SE503.

FINITURE / Finishes

STRUTTURA / Frame
 metallo / metal



0108
 Bianco
 White



0122
 Grafite
 Graphite

PIANO / Top
 gres opaco /
 matt stoneware



3521
 Grafite
 Graphite

PIANO / Top
 vetro / glass



2021
 Grafite
 Graphite



2108
 Extra bianco
 Extra white

MISURE / Size

CRONOS TA1B0 - L 130/200 P 130 H 75 cm

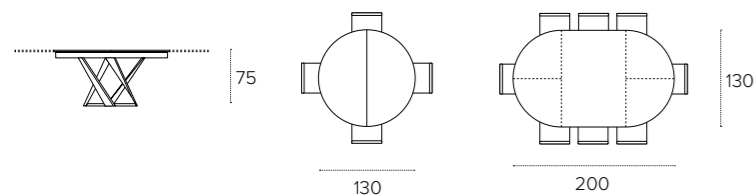

CRONOS WOOD

TAVOLO ROTONDO FISSO /
NON EXTENDABLE ROUND TABLE
COD. TP1B0 - TOP 130 X 130 cm

Tavolo fisso con struttura in metallo verniciato Grafite 0122 e piano rotondo impiallacciato legno rovere Rustico 1027.

Non-extendable table with Graphite 0122 painted metal frame and Country 1027 oak wood veneered round top.
Table fixe avec structure en fer peint Graphite 0122 et plateau rond en placage bois chene Rustique 1027.
Mesa fija con estructura en metal pintado Grafito 0122 y encimera redonda en chapa de madera roble Rústico 1027.

Sedia / Chair / Chaise / Silla MAIORCA SE190.
Madia / Sideboard / Buffet / Aparador ASTRA MA114.
Mensola / Shelf / étagère / Estante CORNER PP118.



CRONOS WOOD

TAVOLO ROTONDO FISSO /
NON EXTENDABLE ROUND TABLE
COD. TP1B0 - TOP 130 X 130 cm

Tavolo fisso con struttura in metallo verniciato Terra 0139 e piano rotondo impiallacciato in legno noce Canaletto 1012.

Non-extendable table with Earth 0139 painted metal frame and Canaletto walnut 1012 wood veneered round top.

Table fixe avec structure en fer peint Terre 0139 et plateau rond en placage bois noyer Canaletto 1012.

Mesa fija con estructura en metal pintado Tierra 0139 y encimera redonda en chapa de madera nogal Canaletto 1012.

Sedia / Chair / Chaise / Silla LUCERNA SE514.

FINITURE / Finishes

STRUTTURA / Frame
metallo / metal



0108
Bianco
White



0122
Grafite
Graphite



0139
Terra
Earth



0640
Silver Spazzolato
Brushed Silver

PIANO / Top
legno / wood



1012
Noce
Walnut



1020
Piombo
Lead



1027
Rustico
Country



1071
Tabacco
Tobacco

MISURE / Size

Ø 130 H 75 cm

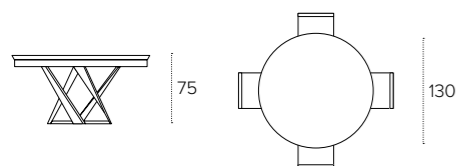

AIACE

TAVOLO ALLUNGABILE / EXTENDABLE TABLE
COD. TA1E1 - TOP 120/180X120 cm

Tavolo allungabile con struttura in metallo verniciato Terra 0139. Piano rotondo ed allunga centrale in laminato spazzolato Argilla 1L46.

Extendable table with Earth 0139 painted metal legs. Round top and central extension in Clay 1L46 brushed laminate.

Table extensible avec structure en fer peint Terre 0139. Plateau rond et allonge centrale en stratifié brossé Argile 1L46.

Mesa extensible con estructura en metal pintado Tierra 0139. Encimera redonda y extensible central en laminado cepillado Arcilla 1L46.

Sedia / Chair / Chaise / Silla MALAGA NEW SE1B0.



AIACE

TAVOLO ALLUNGABILE / EXTENDABLE TABLE
COD. TA1E1 - TOP 120/180X120 cm

Tavolo allungabile con struttura in metallo verniciato Grafite 0122. Piano rotondo ed allunga centrale in laminato spazzolato Vulcano 1L62.

Extendable table with Graphite 0122 painted metal legs. Round top and central extension in Volcan 1L62 brushed laminate.

Table extensible avec structure en fer peint Graphite 0122. Plateau rond et allonge centrale en stratifié brossé Volcan 1L62.

Mesa extensible con estructura en metal pintado Grafito 0122. Encimera redonda y extensible central en laminado cepillado Volcan 1L62.

Sedia / Chair / Chaise / Silla BILBAO SE194.



AIACE

TAVOLO ALLUNGABILE / EXTENDABLE TABLE
COD. TA1E1 - TOP 120/180X120 cm

Tavolo allungabile con struttura in metallo verniciato Bianco 0108. Piano rotondo ed allunga centrale in laminato effetto legno a poro registro Rustico bianco 1728.

Extendable table with White 0108 painted metal legs. Round top and central extension in Country white 1728 wood-effect synchro-texture laminate.

Table extensible avec structure en fer peint Blanc 0108. Plateau rond et allonge centrale en stratifié effet bois à texture syncro Rustique blanc 1728.

Mesa extensible con estructura en metal pintado Blanco 0108. Encimera redonda y extensible central en laminado efecto madera textura sincronica Rustico blanco 1728.

Sedia / Chair / Chaise / Silla DETROIT SE619.



FINITURE / Finishes

STRUTTURA / Frame
 metallo / metal



0108
 Bianco
 White



0112
 Bronzo
 Bronze



0122
 Grafite
 Graphite



0109
 Terra
 Earth

PIANO / Top
 laminato effetto legno /
 wood-effect laminate



1727
 Rustico
 Country



1728
 Rustico Bianco
 White Country

PIANO / Top
 laminato spazzolato /
 brushed laminate



1L46
 Argilla
 Clay



1L62
 Vulcano
 Volcano

MISURE / Size

L 120/180 P 120 H 75 cm

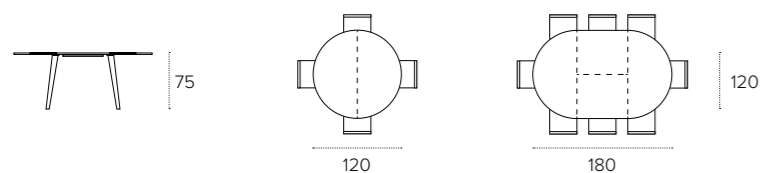

FLUTE

TAVOLO FISSO / NON-EXTENDABLE TABLE
COD. TP116 - TOP 120X120 cm

Tavolo fisso con basamento centrale in metallo verniciato Bianco 0108 e piano rotondo in MDF laccato Bianco 1208.
 Non-extendable table with White 0108 metal central leg and White 1208 lacquered MDF round top.
 Table fixe avec piètement central en fer peint Blanc 0108 et plateau rond en MDF laqué Blanc 1208.
 Mesa fija con base central en metal pinatdo Blanco 0108 y encimera redonda en MDF lacado Blanco 1208.

Sedia/ Chair / Chaise/ Silla VALENCIA SE193.

FINITURE / Finishes

STRUTTURA / Frame
 metallo / metal



0108
 Bianco
 White



0122
 Grafite
 Graphite

PIANO / Top
 laminato lucido /
 glossy lacquered



1408
 Bianco lucido
 Glossy white



1221
 Grafite
 Graphite

MISURE / Size

Ø 120 H 75 cm

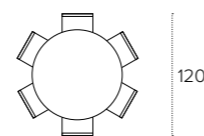

DIONE PLUS

TAVOLO TRASFORMABILE ALLUNGABILE / TRANSFORMABLE EXTENDABLE TABLE
COD. TA150 - TOP 120/200X75 cm

Tavolo allungabile trasformabile a due altezze, con struttura in metallo verniciato, piano in gres porcellanato o vetro temperato ed allunghe laterali in MDF laccato in tinta con il piano.

Double-height transformable and extendable table with painted metal frame. Top in porcelain stoneware or tempered glass and side extensions in lacquered MDF matching the top colour.

Table extensible et transformable à double hauteur avec structure en fer peint, plateau en céramique ou verre trempé et allonges latérales en MDF laqué à jeu avec le plateau.

Mesa extensible y transformable a doble altura con estructura en metal pintado, encimera en gres porcelánico o cristal templado y extensibles laterales en MDF lacado a juego con el color de la encimera.



DIONE PLUS

TAVOLO TRASFORMABILE ALLUNGABILE /
TRANSFORMABLE EXTENDABLE TABLE

COD. TA150 - TOP 120/200X75 cm

avolo allungabile trasformabile a due altezze, con
struttura in metallo verniciato Bronzo 0112, piano in
gres porcellanato effetto marmo Alabastro 3816 ed
allunghe laterali in MDF laccato Bronzo 1212.

Double-hight transformable and extendable table with
Bronze 0112 painted metal frame. Top in Alabaster 3816
marble-effect porcelain stoneware and side extensions
in Bronze 1212 lacquered MDF.

Table extensible et transformable à double hauteur avec
structure en fer peint, Bronze 0112. Plateau en céramique
effet marbre Albatre 3816 et allonges latérales en MDF
laqué Bronze 1212.

Mesa extensible y transformable a doble altura con
estructura en metal pintado Bronce 0112. Encimera
en gres porcelanico efecto marmol Alabastro 3816 y
extensibles laterales en MDF lacado Bronce 1212.

Sedia / Chair / Chaise / Silla FUTURA SE800.

FINITURE / Finishes

STRUTTURA / Frame
metallo / metal



0108
Bianco
White



0112
Bronzo
Bronze



0122
Grafite
Graphite



0139
Terra
Earth

PIANO / Top
gres / stoneware



3521
Grafite
Graphite



3828
Carrara
Carrara



3816
Alabastro
Alabaster



3818
Arabescato
Arabesque



3660
Emperador
Emperador

PIANO / Top
vetro / glass



2088
Bianco
White

MISURE / Size

L 120 / 200 P 75 H 38 / 75 cm

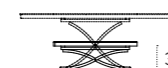

38 | 75

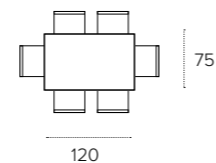

120

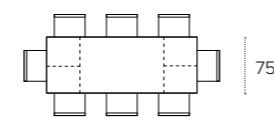

200

75



PANDORA

CONSOLLE ALLUNGABILE / EXTENDABLE CONSOLE

COD. CO507 - TOP 45/500X100 CM

COD. CO506 - TOP 45/300X100 CM

Consolle allungabile con vano interno per riporre le allunghe in laminato spazzolato Vulcano 1L62.
Extendable console with built-in extension storage compartment made in Volcano 1L62 brushed laminate.
Console extensible avec rangement des allonges à l'intérieur réalisée en stratifié brossé Volcan 1L62.
Consola extensible con contenedor de extensibles al interior realizada en laminado cepillado Volcan 1L62.

Sedia/Chaise/Chaise/Silla MALAGA SE195.



PANDORA

CONSOLLE ALLUNGABILE / EXTENDABLE CONSOLE

COD. CO507 - TOP 45/500X100 cm

COD. CO506 - TOP 45/300X100 cm

Consolle allungabile con vano interno per riporre le allunghe in laminato effetto legno Castoro 1724. Extendable console with built-in extension storage compartment made in Beaver 1724 wood-effect laminate.

Consolle extensible avec rangement des allonges à l'intérieur réalisée en stratifié effet bois Castor 1724. Consola extensible con contenedor de extensibles al interior realizada en laminado efecto madera Castor 1724.

Sedia/Chaise/Chaise/Silla GINEVRA SE515.



Consolle allungabile con vano interno per riporre le allunghe in laminato laccato Perla 1128. Extendable console with built-in extension storage compartment made in Pearl 1128 lacquered laminate. Consolle extensible avec rangement des allonges à l'intérieur réalisée en stratifié laqué Perle 1128. Consola extensible con contenedor de extensibles al interior realizada en laminado lacado Perla 1128.

Sedia/Chaise/Chaise/Silla MALAGA NEW SE1B0.

PANDORA

CONSOLLE ALLUNGABILE / EXTENDABLE CONSOLE

COD. CO507 - TOP 45/500X100 cm

COD. CO506 - TOP 45/300X100 cm

COD. CO505 - TOP 45/200X100 cm

FINITURE / Finishes

STRUTTURA / Frame
laminato effetto legno /
wood-effect laminate



1724
Castoro
Beaver



1727
Rustico
Country



1728
Rustico Bianco
White Country

STRUTTURA / Frame
laminato laccato /
lacquered laminate



1128
Perla
Pearl

*disponibili solo per le versioni da 3 e 5 metri CO506 e CO507 / only available for the 3 and 5 meter versions CO506 and CO507

PIANO / Top
laminato spazzolato /
brushed laminate



1L46
Argilla
Clay



1L62
Vulcano
Volcano

*disponibili solo per le versioni da 3 e 5 metri CO506 e CO507 / only available for the 3 and 5 meter versions CO506 and CO507



Dettaglio consolle CO505 chiusa in laminato effetto legno Deserto 1729, con allunghe agganciate.

Detail of closed CO505 console made in Desert 1729 wood-effect laminate with hanging extensions.
Détail de la consolle CO505 fermé réalisée en stratifié effet bois Desert 1729 avec allonges suspendues.
Detalle de la consola CO505 cerrada realizada en laminado efecto madera Desierto 1729 con extensibles colgados.

PANDORA 2m COD. CO505

MISURE / Size

L 100 P 42|93|143|194 H 75 cm

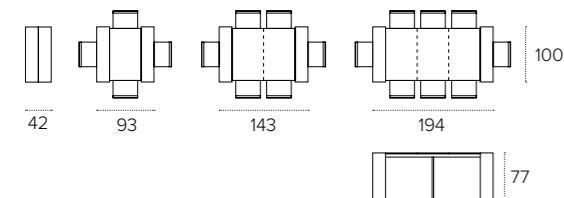

PANDORA 3m COD. CO506

MISURE / Size

L 100 P 42|93|143|194|244|295 H 75 cm

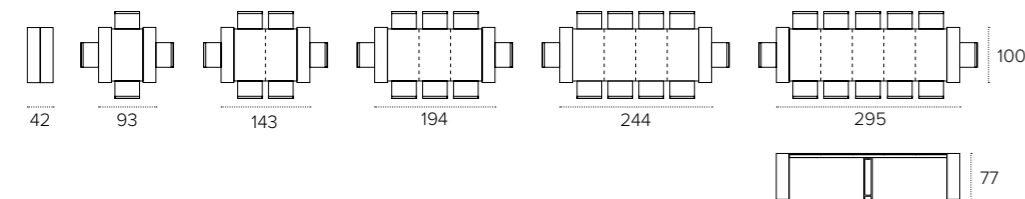

PANDORA 5m COD. CO507

MISURE / Size

L 100 P 42|93|143|194|244|295|345|396|446|497 H 75 cm

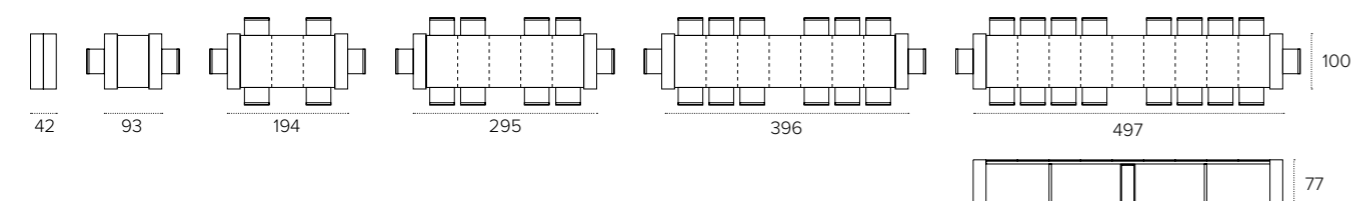

Dettaglio consolle CO506 e CO507 chiusa in laminato effetto legno Rustico 1727.
Detail of closed CO506 and CO507 console made in Country 1727 wood-effect laminate.
Détail de la consolle CO506 et CO507 fermé réalisée en stratifié effet bois Rustique 1727.
Detalle de la consola CO506 y CO507 cerrada realizada en laminado efecto madera Rustico 1727.





MADIE

sideboards / buffets / aparadores

ARTEMIDE

MADIA / SIDEBOARD
COD. MA115

Madia sospesa a quattro ante con corpo in laminato spazzolato Vulcano 1L62. Inserto in gres porcellanato effetto marmo Arabescato 3818 con vena a correre su tutta la lunghezza della madia.

Wall-hanging sideboard with four doors made in Volcano 1L62 brushed laminate. Door inserts in Arabesque 3818 marble-effect stoneware, with same marble vein on all four doors.

Buffet et suspendu à quatre portes en stratifié brossé Volcan 1L62. Inserts en céramique effet marbre Arabesque 3818 avec même veine du marbre sur toute la longueur du buffet.
Aparador suspendido con cuatro puertas en laminado cepillado Volcan 1L62. Inserto en las puertas en porcelánico efecto mármol Arabescato 3818, con misma veta de mármol en toda la longitud del aparador.



ARTEMIDE

MADIA / SIDEBOARD
COD. MA115

Madia a quattro ante con corpo in laminato spazzolato Argilla 1L46. Inserto in gres porcellanato effetto marmo. Emperador 3660 con vena a correre su tutta la lunghezza della madia. Piedini in metallo verniciato Terra 0139.

Sideboard with four doors made in 1L46 Clay brushed laminate. Door inserts in 3660 Emperador marble-effect stoneware, with same marble vein on all four doors. Legs in painted metal Earth 0139.

Buff et à quatre portes en stratifié brossé Argile 1L46. Inserts en céramique effet marbre Emperador 3660 avec meme

veine du marbre sur toute la longueur du buffet. Pieds en fer peint Terre 0139.

Aparador con cuatro puertas en laminado cepillado Arcilla 1L46. Inserto en las puertas en porcelánico efecto mármol Emperador 3660, con misma veta de mármol en toda la longitud del aparador. Patas en metal pintado Tierra 0139.

Sedia / Chair / Chaise / Silla BRASILIA SE1A0.



ARTEMIDE

MADIA / SIDEBOARD
COD. MA115

Madia a quattro ante con corpo in laminato spazzolato Argilla 1L46. Inserto in gres porcellanato effetto marmo Emperador 3660 con vena a correre su tutta la lunghezza della madia. Piedini in metallo verniciato Terra 0139.

Sideboard with four doors made in 1L46 Clay brushed laminate. Door inserts in 3660 Emperador marble-effect stoneware, with same marble vein on all four doors. Legs in painted metal Earth 0139.

Buffet à quatre portes en stratifié brossé Argile 1L46. Inserts en céramique effet marbre Emperador 3660 avec même veine du marbre sur toute la longueur du buffet. Pieds en fer peint Terre 0139.

Aparador con cuatro puertas en laminado cepillado Arcilla 1L46. Inserto en las puertas en porcelánico efecto mármol Emperador 3660, con misma veta de mármol en toda la longitud del aparador. Patas en metal pintado Tierra 0139.

FINITURE / Finishes

BASAMENTO SOSPESO /
 wall-hanging
 metallo / metal

BASAMENTO CENTRALE H 5 cm /
 central basement T H 5 cm
 laminato spazzolato / brushed
 laminate



1L46
 Argilla
 Clay



1L62
 Vulcano
 Volcano

PIEDINI H 20 cm / Feet H 20 cm
 metallo / metal



0112
 Bronzo
 Bronze



0123
 Ferro
 Iron



0139
 Terra
 Earth

PIEDINI H 25 cm / Feet H 25 cm
 metallo / metal



0112
 Bronzo
 Bronze



0123
 Ferro
 Iron



1139
 Terra
 Earth

STRUTTURA / Frame
 laminato spazzolato /
 brushed laminate



1L46
 Argilla
 Clay



1L62
 Vulcano
 Volcano



1L62
 Vulcano
 Volcano



1L46
 Argilla
 Clay

FRONTALE ANTA / Door front
 gres lucido /
 glossy stoneware



3816
 Alabastro
 Alabastro



3828
 Carrara
 Carrara



3818
 Arabescato
 Arabesque



3660
 Emperador
 Emperador

MISURE / Size

L 180 P 50 H 50 cm

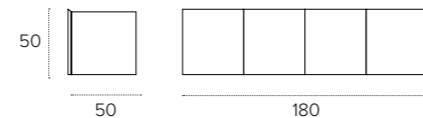

GIUNONE

MADIA / SIDEBOARD
COD. MA112

Madia a tre ante con corpo in laminato effetto legno Rustico bianco 1728. Inserto in gres porcellanato effetto marmo Alabastro 3616 con vena a correre.
Sideboard with three doors in White country 1728 wood-effect laminate with Alabaster 3616 marble-effect stoneware insert. Same marble effect on all three doors.
Buffet à trois portes en stratifié effet bois Rustique blanc 1728 avec insert en céramique effet marbre Alabastro 3616. Meme veine du marbre sur toute la longueur du buffet.
Aparador con tres puertas en laminado efecto madera Rustico blanco 1728 con inserto en gres porcelánico efecto mármol Alabastro 3616. Misma veta de mármol en toda la longitud de las puertas.



GIUNONE

MADIA / SIDEBOARD
COD. MA112

Madia a tre ante con corpo in laminato castoro 1724. Ante in laminato castoro 1724 con inserto gres porcellanato carrara 3608 con vena a correre.

Sideboard with three doors, with body in 1724 beaver laminate. Doors in 1724 beaver laminate with 3608 carrara marble-effect stoneware insert. Same marble effect on all three doors.

Buffet à trois portes avec structure en stratifié castor 1724. Portes en stratifié castor 1724 avec insert en céramique effet marbre carrare 3608. Meme veine du marbre sur toute la longueur du buffet.

Aparador con tres puertas con cuerpo en laminado castor 1724. Puertas en laminado castor 1724 con inserto en gres porcelánico efecto mármol carrara 3608. Misma veta de mármol en toda la longitud de las puertas.

Tavolo/table/table/mesa Priamo 230 botticella cod. TP162.

Sedie/chairs/chaïses/sillas Bilbao cod. SE194.

Tavolino/coffe table/table basse/mesita Priamo cod. TL165.

Mensola/shelf/étagère/estante Corner cod. PP118.

Tavolo/table/table/mesa Priamo 180 cod. TP1A1.



GIUNONE

MADIA / SIDEBOARD
COD. MA112

Madia a tre ante con corpo in laminato castoro 1724. Ante in laminato castoro 1724 con inserto gres porcellanato carrara 3608 con vena a correre.

Sideboard with three doors, with body in 1724 beaver laminate. Doors in 1724 Beaver laminate with 3608 carrara marble-effect stoneware insert. Same marble effect on all three doors.

Buffet à trois portes avec structure en stratifié castor 1724. Portes en stratifié castor 1724 avec insert en céramique effet marbre carrare 3608. Meme veine du marbre sur toute la longueur du buffet.

Aparador con tres puertas con cuerpo en laminado castor 1724. Puertas en laminado castor 1724 con inserto en gres porcelánico efecto mármol carrara 3608. Misma veta de mármol en toda la longitud de las puertas.



GIUNONE

MADIA / SIDEBOARD
COD. MA112

Madia a tre ante con corpo in laminato rustico 1727. Ante in laminato rustico 1727 con inserto gres porcellanato emperador 3660 con vena a correre.

Sideboard with three doors with body in 1727 country laminate. Doors in 1727 country laminate with 3660 emperador marble-effect stoneware insert. Same marble effect on all three doors.

Buffet à trois portes avec structure en stratifié rustique 1727. Portes en stratifié rustique 1727 avec insert en céramique effet marbre emperador 3660. Meme veine du marbre sur toute la longueur du buffet.

Aparador de tres puertas con cuerpo en laminado roble rústico 1727. Puertas en laminado roble rústico 1727 con inserto en gres porcelánico efecto mármol emperador 3660. Misma veta de mármol en toda la longitud de las puertas.

Tavolo/table/table/mesa Vortice cod. TA1B6.

Sedie/chairs/chaïses/sillas Bellinzona cod. SE507.

Tavolino/coffe table/table basse/mesita Traslo cod. TL525.



GIUNONE

MADIA / SIDEBOARD
COD. MA112

Madia a tre ante con corpo in laminato castoro 1724. Ante in laminato castoro 1724 con inserto gres porcellanato arabescato 3618 con vena a correre. Sideboard with three doors with body in 1724 beaver laminate. Doors in 1724 beaver laminate with 3618 arabesque marble-effect stoneware insert. Same marble effect on all three doors.

Buffet à trois portes avec structure en stratifié castor 1724. Portes en stratifié castor 1724 avec insert en céramique effet marbre arabesque 3618. Meme veine du marbre sur toute la longueur du buffet.

Aparador con tres puertas con cuerpo en laminado castor 1724. Puertas en laminado castor 1724 con inserto en gres porcelánico efecto mármol arabescato 3618. Misma veta de mármol en toda la longitud de las puertas.



GIUNONE

MADIA / SIDEBOARD
COD. MA112

Madia a tre ante con corpo in laminato castoro 1724.

Ante in laminato castoro 1724 con inserto gres porcellanato arabescato 3618 con vena a correre.

Sideboard with three doors with body in 1724 beaver laminate. Doors in 1724 beaver laminate with 3618 Arabesque marble-effect stoneware insert. Same marble effect on all three doors.

Buffet à trois portes avec structure en stratifié castor 1724. Portes en stratifié castor 1724 avec insert en céramique effet marbre arabesque 3618. Meme veine du marbre sur toute la longueur du buffet.

Aparador con tres puertas con cuerpo en laminado castor 1724.

Puertas en laminado castor 1724 con inserto en gres porcelánico efecto mármol arabescato 3618. Misma veta de mármol en toda la longitud de las puertas.

FINITURE / Finishing

BASAMENTO CENTRALE H 5 cm /
 central basement H 5 cm
 laminato spazzolato / brushed laminate



1L46
Argilla
Clay



1L62
Vulcano
Volcano

PIEDINI H 20 cm / Feet H 20 cm
 metallo / metal



0112
Bronzo
Bronze



0123
Ferro
Iron



0139
Terra
Earth

STRUTTURA E ANTE /
 Frame and doors
 laminato effetto legno /
 wood-effect laminate



1724
Castoro
Beaver



1724
Castoro
Beaver



1727
Rustico
Country



1728
Rustico Bianco
White Country

FRONTALE ANTA /
 Door front
 gres lucido /
 glossy stoneware



3608
Carrara
Carrara



3618
Arabescato
Arabesque



3660
Emperador
Emperador



3616
Alabastro
Alabastro

FINITURE / Finishing

STRUTTURA E ANTE /
 Frame and doors
 laminato effetto legno /
 wood-effect laminate



1L62
Vulcano
Volcano



1L62
Vulcano
Volcano



1L46
Argilla
Clay



1L46
Argilla
Clay

FRONTALE ANTA /
 Door front
 gres lucido /
 glossy stoneware



3608
Carrara
Carrara



3618
Arabescato
Arabesque



3660
Emperador
Emperador



3616
Alabastro
Alabastro

MISURE / Size

L 180 P 49 H 83 cm

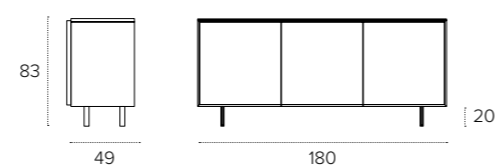

MODUS

MADIA / SIDEBOARD
COD. MA108

Madia con corpo in laminato effetto legno Rustico 1727 con due ante scorrevoli di cui una in ferro vintage Terra 0139 con decoro Rosone 02.

Laminate sideboard with two sliding doors, with body in Country 1727 wood-effect laminate. One of the sliding doors is in Earth 0139 painted metal with Rose 02 decoration. Buffet à deux portes coulissantes, avec structure en stratifié effet bois Rustique 1727. Une des portes est en fer peint Terre 0139 avec décoration optionnelle Rose 02. Aparador con dos puertas correderas, con cuerpo en laminado efecto madera roble Rústico 1727. Una de las puertas es en metal pintado Tierra 0139 con decoración opcional Rosa 02.

Tavolo / Table / Table / Mesa ASTERION TA194.
Sedia / Chair / Chaise / Silla BILBAO SE194.
Mensola / Shelf / Étagère / Estante MODUS ML501.



MODUS

MADIA / SIDEBOARD
COD. MA108

Madia con corpo in laminato effetto legno Rustico 1727 con due ante scorrevoli di cui una in ferro vintage Terra 0139 con decoro Rosone 02.

Laminate sideboard with two sliding doors, with body in Country 1727 wood-effect laminate. One of the sliding doors is in Earth 0139 painted metal with Rose 02 decoration.

Buffet à deux portes coulissantes, avec structure en stratifié effet bois Rustique 1727. Une des portes est en fer peint Terre 0139 avec décoration optionnelle Rose 02.

Aparador con dos puertas correderas, con cuerpo en laminado efecto madera roble Rústico 1727. Una de las puertas es en metal pintado Tierra 0139 con decoracion opcional Rosa 02.



MODUS

MADIA / SIDEBOARD
COD. MA108

Madia in finitura castoro 1724 con optional anta decorata in lamiera rosone 02.

Laminate sideboard in beaver 1724 finishing, with optional rose 02 decorated metal on the sliding door.

Buffet en stratifié en finition castor 1724, avec métal optionnel décoré rose 02 sur la porte coulissante.

Aparador en laminado acabado castor 1724, con metal opcional y decoracion rosone 02 en la puerta corredera.

Boiserie / boiserie / panneau mural decoratif / panel mural cod. QU101.



MODUS

MADIA / SIDEBOARD
COD. MA108

Madia in finitura castoro 1724 con optional anta decorata in lamiera Rosone 02.

Laminate sideboard in beaver 1724 finishing, with optional Rose 02 decorated metal on the sliding door.

Buffet en stratifié en finition castor 1724, avec métal optionnel décoré Rose 02 sur la porte coulissante.

Aparador en laminado acabado castor 1724, con metal opcional y decoracion Rosone 02 en la puerta corredera.

Boiserie/boiserie/panneau mural decoratif/panel mural cod. QU101.



MODUS

MADIA / SIDEBOARD
 COD. MA108



FINITURE / Finishes

PIEDINI H 20 cm / feet
 H 20 cm



0123
 Ferro Vintage
 Vintage iron



0139
 Terra
 Earth



0112
 Bronzo
 Bronze

STRUTTURA E ANTE /
 Frame and doors
 laminato / laminate



1724
 Castoro
 Beaver



1727
 Rustico
 Country



1728
 Rustico Bianco
 White Country

ANTE OPZIONALE/
Optional doors
 lamiera / metal sheet



00
 Ferro Vintage
 Vintage iron



01
 Ferro Rete
 Mesh iron



02
 Ferro Rosone
 Rose iron

MISURE / Size

L 192 P 54 H 81/20 cm

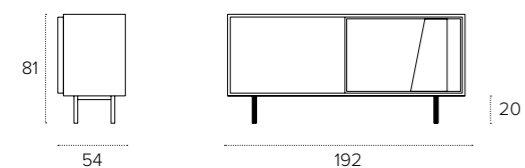

Madia con corpo in laminato Rustico Bianco 1728 con due ante scorrevoli di cui una in ferro vintage 0123. Laminated sideboard with two sliding doors, with body in Country white laminate 1728. One of the sliding doors is in 0123 vintage iron painted metal. Buffet à deux portes coulissantes, avec structure en stratifié Rustique blanc 1728. Une des portes est en fer peint fer vintage 0123. Aparador con dos puertas correderas, con cuerpo en laminado Rústico Blanco 1728. Una de las puertas es en metal pintado hierro vintage 0123.

Tavolo/table/table/mesa Apollo 160 cod. TA1C4
 Sedie/chairs/chaises/sillas Vienna cod. SE608

MODUS NEW

MADIA / SIDEBBOARD
COD. MA110

Madia con corpo in laminato effetto legno Castoro 1724 e due ante scorrevoli di cui una con inserto in gres porcellanato effetto marmo Arabescato 3618.
Laminated sideboard with two sliding doors with body in Beaver 1724 wood-effect laminate. Decorative insert in Arabesque 3618 marble-effect porcelain gres stoneware.
Buffet à deux portes coulissantes en stratifié effet bois Castor 1724. Insert décoratif en céramique effet marbre Arabesque 3618 sur une des deux portes.
Aparador con dos puertas correderas en laminado efecto madera Castor 1724. Inserto en gres porcelánico efecto mármol Arabescato 3618 en una de las dos puertas.



MODUS NEW

MADIA / SIDEBOARD
COD. MA110

Madia in laminato effetto legno Castoro 1724 con due ante scorrevoli di cui una con inserto in gres porcellanato effetto marmo Carrara 3608.

Sideboard with two sliding doors made in Beaver 1724 wood-effect laminate. Decorative insert in Carrara 3608 marble-effect stoneware on one of the sliding doors.
Buffet à deux portes coulissantes, avec structure en stratifié effet bois Castor 1724. Insert décoratif en céramique effet marbre Carrare 3608 sur une des portes.
Aparador con dos puertas correderas en laminado efecto madera Castor 1724. Inserto en gres porcelánico efecto mármol Carrara 3608 en una de las puertas.



MODUS NEW

MADIA / SIDEBOARD
COD. MA110

Madia con corpo e due ante scorrevoli in laminato effetto legno rustico 1727.

Laminate sideboard with two sliding doors in 1727 country wood-effect laminate.

Buff et à deux portes coulissantes en stratifié effet bois rustique 1727.

Aparador con dos puertas correderas en laminado efecto madera rústico 1727.

Sedia/Chair/Chaise/Silla MAIORCA SE190

Tavolo/Table/Table/Mesa NON DISPONIBILE - NOT AVAILABLE



MODUS NEW

MADIA / SIDEBOARD
COD. MA110

Madia con corpo e due ante scorrevoli in laminato rustico bianco 1728.

Laminate sideboard with two sliding doors in 1728 country white laminate.

Buffet à deux portes coulissantes, avec structure en stratifié rustique blanc 1728.

Aparador con dos puertas correderas en laminado rústico blanco 1728.



MODUS NEW

MADIA / SIDEBOARD
COD. MA110

Madia con corpo e due ante scorrevoli in laminato spazzolato vulcano 1L62.

Laminated sideboard with two sliding doors, in 1L62 volcano brushed laminate.

Buffet à deux portes coulissantes, avec structure et portes en stratifié brossé volcan 1L62.

Aparador con dos puertas correderas, con cuerpo y puertas en laminado cepillado volcan 1L62.

Tavolo/table/table/mesa Asterion 160 cod. TA1C5.

Sedie/chairs/chaises/sillas Lugano cod. SE504.



MODUS NEW

MADIA / SIDEBBOARD
COD. MA110

Madia con corpo e due ante scorrevoli in laminato spazzolato Argilla 1L46.

Laminated sideboard with two sliding doors in 1L46 Clay brushed laminate.

Buffet à deux portes coulissantes, avec structure et portes en stratifié brossé Argile 1L46.

Aparador con dos puertas correderas, con cuerpo y puertas en laminado cepillado Arcilla 1L46.

FINITURE / Finishing

BASAMENTO CENTRALE H 5 cm /
 central basement T H 5 cm
 laminato spazzolato / brushed laminate



1L46
 Argilla
 Clay



1L62
 Vulcano
 Volcano

PIEDINI H 20 cm / Feet H 20 cm
 metallo / metal



0112
 Bronzo
 Bronze



0123
 Ferro
 Iron



0139
 Terra
 Earth

PIEDINI H 25 cm / Feet H 25 cm
 metallo / metal



0112
 Bronzo
 Bronze



0123
 Ferro
 Iron



0139
 Terra
 Earth

STRUTTURA E ANTE /
 Frame and doors
 laminato / laminate



1724
 Castoro
 Beaver



1727
 Rustico
 Country



1728
 Rustico Bianco
 White Country



1L46
 Argilla
 Clay



1L62
 Vulcano
 Volcano

INSERTO OPZIONALE /
Optional insert
 gres / stoneware



3608
 Carrara
 Carrara



3618
 Arabescato
 Arabesque



3660
 Emperador
 Emperador



3616
 Alabastro
 Alabaster

MISURE / Size

L 192 P 54 H 81/20 cm

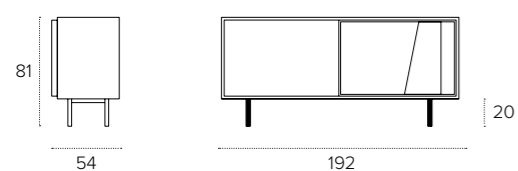

VERSUS 210

MADIA / SIDEBOARD
COD. MA101

Madia con due ante e tre cassetti in laminato effetto legno castoro 1724.

Laminate sideboard with two doors and three drawers in 1724 beaver wood-effect laminate.

Buffet à deux portes et trois tiroirs en stratifié effet bois castor 1724.

Aparador con dos puertas y tres cajones en laminado efecto madera castor 1724.

Tavolo/table/table/mesa Apollo 180 cod. TA1C3.

Sedie/chairs/chaises/sillas Ginevra cod. SE515.



VERSUS 210

MADIA / SIDEBOARD
COD. MA101

Madia con corpo in laminato rustico 1727. Anta diagonale e cestone in laminato perla 1128.

Laminate sideboard with two doors and three drawers. Body in 1727 country laminate, diagonal door and big drawer in 1128 pearl laminate.

Buffet à deux portes et trois tiroirs. Structure en stratifié chêne rustique 1727, porte diagonale et tiroir grand en stratifié perle 1128.

Aparador con dos puertas y tres cajones. Cuerpo en laminado roble rústico 1727, puerta diagonal y cajon grande en laminado perla 1128.



VERSUS 166

MADIA / SIDEBOARD
COD. MA100

Madia con corpo in laminato effetto legno rustico 1727.

Laminate sideboard with two doors and three drawers in 1729 desert wood-effect laminate.

Buffet à deux portes et trois tiroirs en stratifié effet bois rustique 1727.

Aparador con dos puertas y tres cajones, todo en laminado efecto madera rústico 1727.



VERSUS 166

MADIA / SIDEBOARD
COD. MA100

Madia in laminato con due ante e tre cassetti. Corpo e cassetti in laminato laccato perla 1128. Anta diagonale e cestone in laminato effetto legno rustico 1727.

Laminate sideboard with two doors and three drawers. Body in 1128 pearl laminate, diagonal door and big drawer in 1727 country wood-effect laminate.

Buffet à deux portes et trois tiroirs. Structure en stratifié laqué perle 1128, porte diagonale et tiroir grand en stratifié effet bois rustique 1727.













Aparador con dos puertas y tres cajones. Cuerpo en laminado lacado perla 1128, puerta diagonal y cajon grande en laminado efecto madera rustico 1727.



VERSUS 210

MADIA / SIDEBBOARD
VERSUS 210 COD. MA101
VERSUS 166 COD. MA100

FINITURE / Finishes

BASAMENTO / Base metallo / metal				
 0123 Ferro Vintage Vintage iron				
STRUTTURA / Frame laminato / laminate				
 1724 Castoro Beaver	 1727 Rustico Country	 1128 Perla Pearl	 1729 Deserto Desert	
ANTE / Doors laminato / laminate				
 1724 Castoro Beaver	 1727 Rustico Country	 1128 Perla Pearl	 1729 Deserto Desert	
PIANO OPZIONALE / Optional top lamiera / metal sheet				
 0123 Ferro Vintage Vintage iron	 01 Ferro Rete Mesh iron	 02 Ferro Rosone Rose iron		

MISURE / Size

L 210 P 53 H 80/20 cm

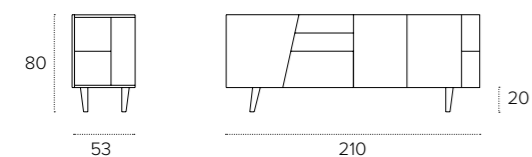

MISURE / Size

L 166 P 53 H 80/20 cm

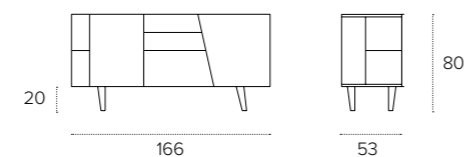

Madia con due ante e tre cassetti in finitura laminato effetto legno deserto 1729.
 Laminated sideboard with two doors and three drawers in desert 1729 wood-effect laminate.
 Buffet avec deux portes et trois tiroirs en en stratifié effet bois désert 1729.
 Aparador con dos puertas y tres cajones en laminado efecto madera desierto 1729.



ELECTA

MADIA / SIDEBOARD
COD. MA103

Madia tre ante e tre cassetti con vena a correre in laminato rustico 1727 e optional top gres porcellanato emperador 3660.

Laminate sideboard with three doors and three drawers in 1727 country laminate. Optional top in 3660 emperador marble-effect stoneware. Same wood effect running on all three doors.

Buffet à trois portes et trois tiroirs en stratifié chene rustique 1727. Plateau optionnel en céramique effet marbre emperador 3660. Même flamme du bois sur les trois portes. Aparador con tre puertas y tres cajones, todo en laminado roble rústico 1727. Encimera opcional en porcelánico efecto marmol emperador 3660. Misma veta de madera en toda la longitud del aparador.



ELECTA

MADIA / SIDEBOARD
COD. MA103

Madia tre ante e tre cassetti con vena a correre in laminato castoro 1724 e optional top gres porcellanato arabescato 3618.

Laminate sideboard with three doors and three drawers in 1724 beaver laminate. Optional top in 3618 arabesque marble-effect stoneware. Same wood effect running on all three doors.

Buffet à trois portes et trois tiroirs en stratifié castor 1724. Plateau optionnel en céramique effet marbre arabesque 3618. Même flamme du bois sur les trois portes.

Aparador con tres puertas y tres cajones, todo en laminado castor 1724. Encimera opcional en porcelánico efecto marmol arabescato 3618. Misma veta de madera en toda la longitud del aparador.

Tavolo/table/table/mesa Tornado cod. TA1B5.
Sedie/chairs/chaises/sillas Malaga cod. SE195.



ELECTA

MADIA / SIDEBOARD
COD. MA103

Madia tre ante e tre cassetti con vena a correre in laminato castoro 1724 e optional top gres porcellanato arabescato 3618.

Laminate sideboard with three doors and three drawers in 1724 beaver laminate. Optional top in 3618 arabesque marble-effect stoneware. Same wood effect running on all three doors.

Buffet à trois portes et trois tiroirs en stratifié castor 1724. Plateau optionnel en céramique effet marbre arabesque 3618. Même flamme du bois sur les trois portes.

Aparador con tres puertas y tres cajones, todo en laminado castor 1724. Encimera opcional en porcelánico efecto marmol arabescato 3618. Misma veta de madera en toda la longitud del aparador.

FINITURE / Finishes

BASAMENTO / Base
 metallo / metal



0123
Ferro Vintage
Vintage iron



0139
Terra
Earth

STRUTTURA / Frame
 laminato / laminate



1724
Castoro
Beaver



1727
Rustico
Country



1128
Perla
Pearl



1729
Deserto
Desert

ANTE / Doors
 laminato / laminate



1724
Castoro
Beaver



1727
Rustico
Country



1128
Perla
Pearl



1729
Deserto
Desert

INSERTO OPZIONALE /
Optional insert
 gres / stoneware



3608
Carrara
Carrara



3618
Arabescato
Arabesque



3616
Alabastro
Alabastro



3660
Emperador
Emperador

MISURE / Size

L 179 P 53 H 82/20 cm

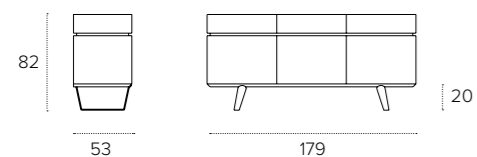

ASTRA

MADIA / SIDEBBOARD
COD. MA114

Madia con corpo e cassetti impiallacciati legno noce canaletto 1012 e ante in laminato porfido ossidato 1121.
Sideboard with body and drawers in 1012 canaletto walnut veneer wood and doors in 1121 oxidized porphyry laminate.
Buffet avec structure et tiroirs en placage bois noyer canaletto 1012. Portes stratifié porphyre oxydé 1121.
Aparador con cuerpo y cajones en chapa de madera nogal canaletto 1012 y puertas en laminado pórfido oxidado 1121.



ASTRA

MADIA / SIDEBOARD
COD. MA114

Madia con corpo e cassetti impiallacciati legno rustico 1027 e ante in laminato porfido ossidato 1121.
 Sideboard with body and drawers in 1027 country oak veneer wood and doors in 1121 oxidized porphyry laminate.
 Buffet avec structure et tiroirs en placage bois chene rustique 1027. Portes stratifié porphyre oxydé 1121.
 Aparador con cuerpo y cajones en chapa de madera roble rústico 1027 y puertas en pórfido oxidado laminado 1121.



FINITURE / Finishes

BASAMENTO / Base
 metallo / metal



0123
 Ferro Vintage
 Vintage iron

STRUTTURA / Frame
 legno / wood



1012
 Noce
 Walnut



1020
 Piombo
 Lead



1027
 Rustico
 Country



1071
 Tabacco
 Tobacco

ANTE / Doors
 laminato / laminate



1121
 Porfido ossidato
 Oxidized porphyry

MISURE / Size

L 120 P 49 H 141 cm

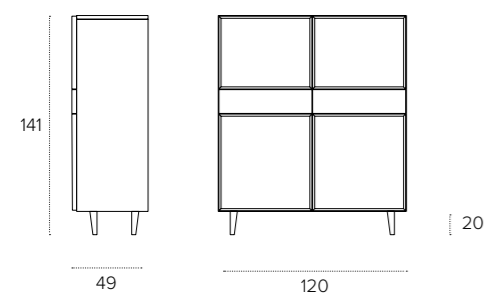

MINERVA

MADIA / SIDEBOARD
COD. MA113

Madia con corpo e cassetti impiallacciati legno tabacco 1071 e ante in laminato porfido ossidato 1121.
Sideboard with body and drawers in 1071 tobacco veneer wood and doors in 1121 oxidized porphyry laminate.
Buffet avec structure et tiroirs en placage bois tabac 1071. Portes stratifié porphyre oxydé 1121.
Aparador con cuerpo y cajones en chapa de madera Tabaco 1071 y puertas en laminado pórvido oxidado 1121.

Tavolo/table/table/mesa Priamo 230 botticella cod. TP162.
Sedie/chairs/chaises/sillas Vienna cod. SE608.



MINERVA

MADIA / SIDEBOARD
COD. MA113

Madia con corpo e cassetti impiallacciati legno tabacco 1071 e ante in laminato porfido ossidato 1121.
Sideboard with body and drawers in 1071 tobacco veneer wood and doors in 1121 oxidized porphyry laminate.
Buffet avec structure et tiroirs en placage bois tabac 1071. Portes stratifié porphyre oxydé 1121.
Aparador con cuerpo y cajones en chapa de madera tabaco 1071 y puertas en laminado pórfido oxidado 1121.



MINERVA

MADIA / SIDEBOARD
COD. MA113

Madia con corpo e cassetti impiallacciati legno piombo 1020 e ante in laminato porfido ossidato 1121.
Sideboard with body and drawers in 1020 lead veneer wood and doors in 1121 oxidized porphyry laminate.
Buffet avec structure et tiroirs en placage bois plomb 1020. Portes stratifié porphyre oxydé 1121.
Aparador con cuerpo y cajones en chapa de madera plomo 1020 y puertas en laminado pórfido oxidado 1121.

Tavolo/table/table/mesa Eclipse 230 rettangolare cod. TP407.
Sedie/chairs/chaises/sillas Bellinzona cod. SE507.



MINERVA

MADIA / SIDEBOARD
COD. MA113

Madia con corpo e cassetti impiallacciati legno noce canaletto 1012 e ante in laminato porfido ossidato 1121. Sideboard with body and drawers in 1012 canaletto walnut veneer wood and doors in 1121 oxidized porphyry laminate. Buffet avec structure et tiroirs en placage bois noyer canaletto 1012 et portes stratifié porphyre oxydé 1121. Aparador con cuerpo y cajones en chapa de madera nogal canaletto 1012 y puertas en laminado pórfido oxidado 1121.

Mensola/shelf/étagère/estante Minerva cod. ML503.



MINERVA

MADIA / SIDEBOARD
COD. MA113

Madia con corpo e cassetti impiallacciati legno noce canaletto 1012 e ante in laminato porfido ossidato 1121.
Sideboard with body and drawers in 1012 canaletto walnut veneer wood and doors in 1121 oxidized porphyry laminate.
Buffet avec structure et tiroirs en placage bois noyer canaletto 1012. Portes stratifié porphyre oxydé 1121.
Aparador con cuerpo y cajones en chapa de madera nogal canaletto 1012 y puertas en laminado pórfido oxidado 1121.



FINITURE / Finishes

BASAMENTO / Base
metallo / metal



0123
Ferro Vintage
Vintage iron

STRUTTURA / Frame
legno / wood



1012
Noce
Walnut



1020
Piombo
Lead



1027
Rustico
Country



1071
Tabacco
Tobacco

ANTE / Doors
laminato / laminate



1121
Porfido ossidato
Oxidized porphyry

MISURE / Size

L 180 P 49 H 83 cm

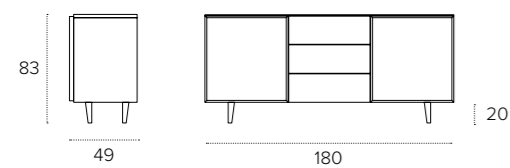

FINITURE

FINISHES / FINITIONS / ACABADOS

METALLO / Metal / Métal / Metal



0108
BIANCO
White / Blanc / Blanco



0110
NERO
Black / Noir / Negro



0112
BRONZO
Bronze / Bronze / Bronce



0122
GRAFITE
Graphite / Graphite / Grafito

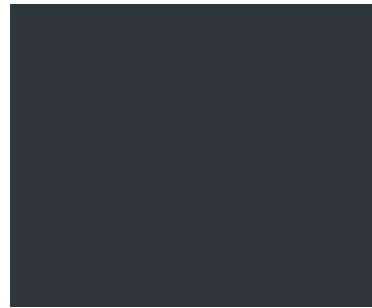

0123
FERRO VINTAGE
Vintage Iron / Fer Vintage /
Hierro Vintage



0124
GHIACCIO
Ice Grey / Gris Glace / Gris Hielo



0139
TERRA
Earth / Terre / Tierra



0140
ARGENTO
Silver / Argent / Plata



0166
CORDA
Rope / Corde / Cuerda

AGGLOMERATO DI MARMO / Marble agglomerate / Aggloméré de marbre / Aglomerado de mármol

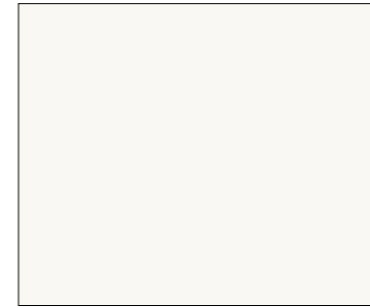

3008
BIANCO
White / Blanc / Blanco



3012
BRONZO
Bronze / Bronze / Bronce



3021
GRAFITE
Graphite / Graphite / Grafito



3039
TERRA
Earth / Terre / Tierra

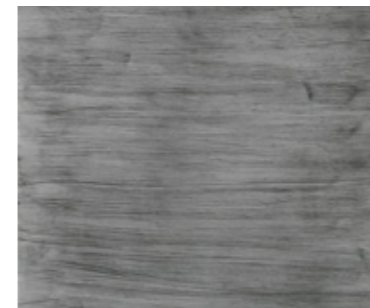

3040
SPAZZOLATO ARGENTO
Silver brushed / Brossé argent /
Cepillado plata



3004
ORO
Gold / Or / Oro



3010
NERO
Black / Noir / Negro

POLIURETANO / Polyuretan / Polyuréthane / Poliuretano

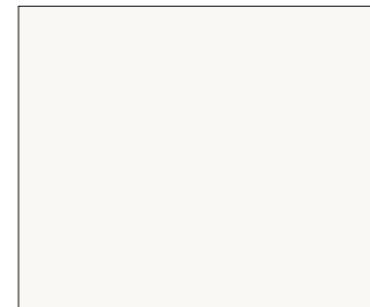

8208
BIANCO
White / Blanc / Blanco



8212
BRONZO
Bronze / Bronze / Bronce



8221
GRAFITE
Graphite / Graphite / Grafito

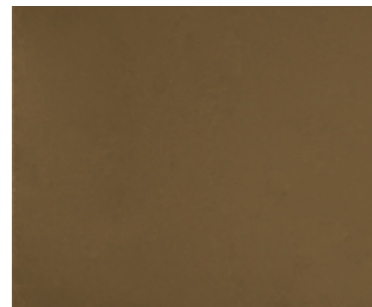

8239
TERRA
Earth / Terre / Tierra



8204
ORO
Gold / Or / Oro



8210
NERO
Black / Noir / Negro

FINITURE

FINISHES / FINITIONS / ACABADOS

LAMINATO EFFETTO METALLO / Metal-effect laminate / Stratifié effet métal / Laminado efecto metal

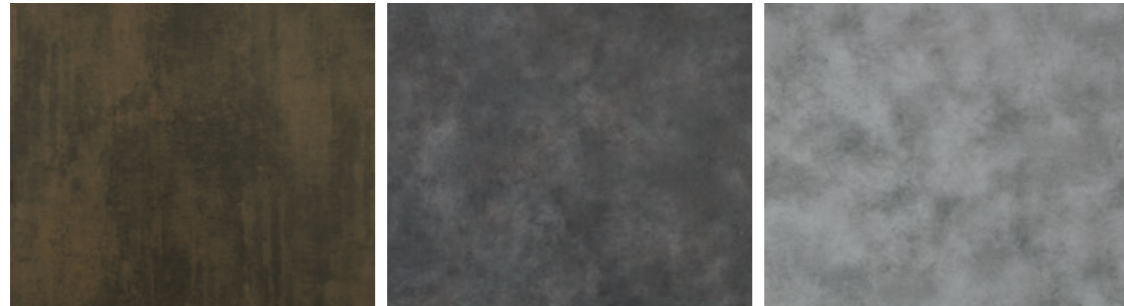

1F02
BRONZO
Bronze / Bronze / Bronze

1F22
PIOMBO
Lead / Plomb / Plomo

1F40
ARGENTO
Silver / Argent / Plata

HPL / High Pressure Laminate / Laminé Haute Pression / Laminado Alta Densidad

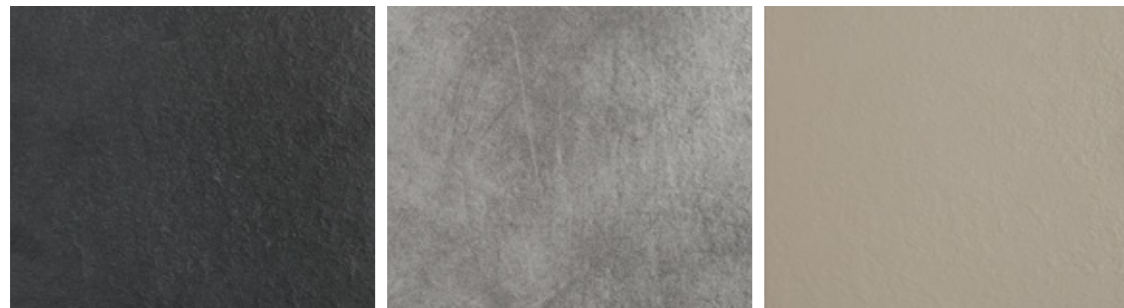

1D21
GRAFITE
Graphite / Graphite / Grafito

1D24
GHIACCIO
Ice Grey / Gris Glace / Gris Hielo

1D66
CORDA
Rope / Corde / Cuerda

LAMINATO EFFETTO LEGNO / Wood-effect laminate / Stratifié effet bois / Laminado efecto madera



1728
RUSTICO BIANCO
Country white / Blanc rustique /
Rústico blanco

1724
CASTORO
Beaver / Castor / Castor

1727
RUSTICO
Country / Rustique / Rústico

1729
DESERTO
Desert / Désert / Desierto

LAMINATO SPAZZOLATO / Brushed laminate / Stratifié brossé / Laminado cepillado



1L46
ARGILLA
Clay / Argile / Arcilla

1L62
VULCANO
Volcano / Volcan / Volcán

LEGNO / Wood



1012
NOCE CANALETTO
Canaletto Walnut / Noyer Canaletto /
Nogal Canaletto

1020
ROVERE PIOMBO
Lead Oak / Chêne Plomb /
Roble Plomo

1027
ROVERE RUSTICO
Country Oak / Chêne Rustique /
Roble Rústico

1071
ROVERE TABACCO
Tobacco Oak / Chêne Tabac /
Roble Tabaco

LEGNO LACCATO / Lacquered wood / Bois laqué / Madera lacada

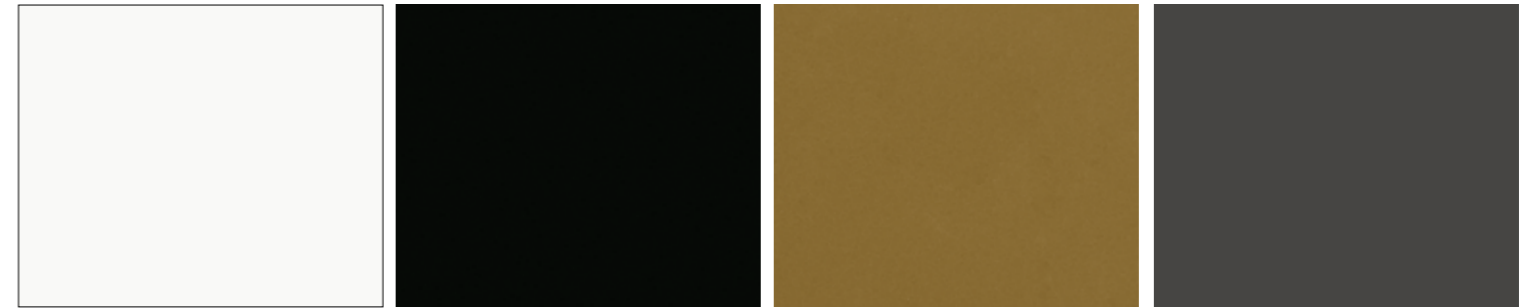

1208
BIANCO
White / Blanc / Blanco

1210
NERO
Black / Noir / Negro

1212
BRONZO
Bronze / Bronze /
Bronce

1221
GRAFITE
Graphite / Graphite / Grafito



1224
GHIACCIO
Ice Grey / Gris Glace /
Gris Hielo

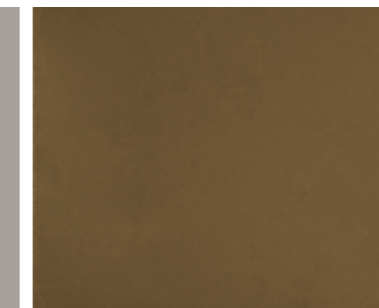

1239
TERRA
Earth / Terre / Tierra

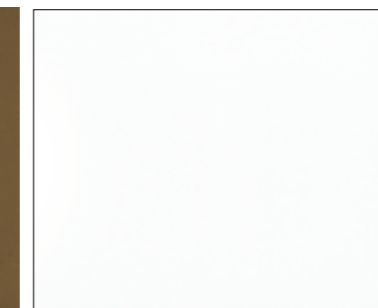

1408
BIANCO LUCIDO
Glossy white / Blanc brillant /
Blanco brillante

FINITURE

FINISHES / FINITIONS / ACABADOS

VETRO / Tempered glass / Verre trempé / Cristal templado



2001
TRASPARENTE
Transparent / Transparent /
Transparente

2021
GRAFITE
Graphite / Graphite / Grafito

2108
EXTRA BIANCO
Extra White / Extra Blanc
Extra Blanco

GRES OPACO / Matt porcelain gres stoneware / Céramique grès opaque / Gres porcelánico mate

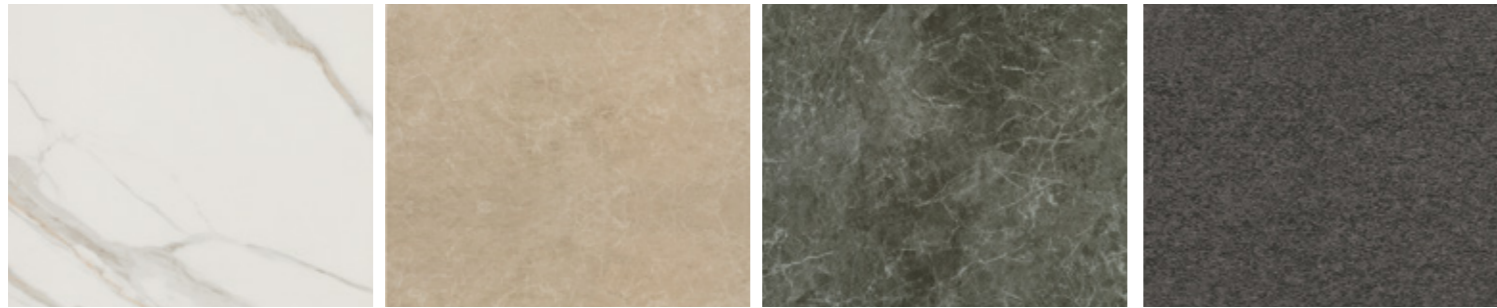

3808
CALACATTA
Calacatta / Calacatta / Calacatta

3825
SABBIA
Sand / Sable / Arena

3822
FIORDIBOSCO
Fiordibosco / Fiordibosco / Fiordibosco

3521
GRAFITE
Graphite / Graphite / Grafito

GRES LUCIDO / Glossy porcelain gres stoneware / Céramique grès brillante / Gres porcelánico brillo

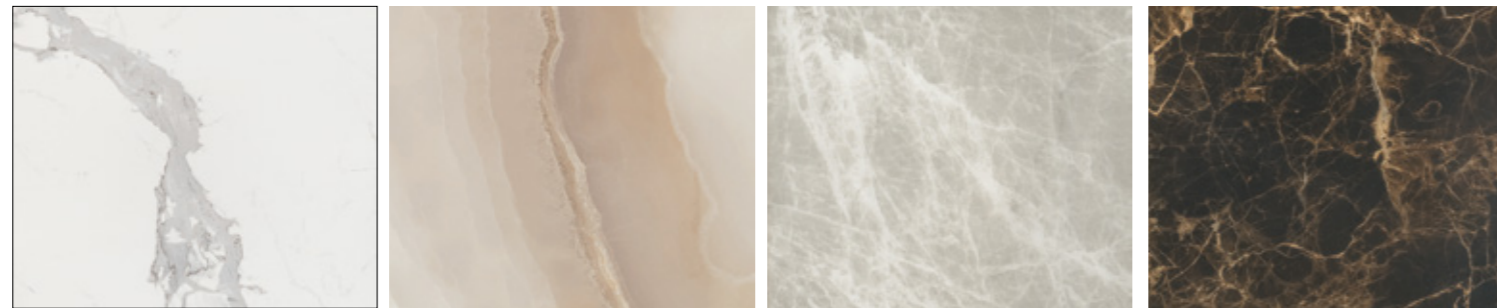

3608 / 3828
CARRARA
Carrara / Carrara / Carrara

3616 / 3816
ALABASTRO
Alabaster / Albâtre / Alabastro

3618 / 3818
ARABESCATO
Arabesque / Arabesque / Arabescato

3660
EMPERADOR
Emperador / Emperador / Emperador

CERTIFICAZIONI

CERTIFICATIONS / CERTIFICATIONS / CERTIFICACIONES



Le componenti in legno ed i pannelli che utilizziamo sono certificati in classe E1 (a bassa emissione di formaldeide).

The wooden components and panels we use are certified in class E1 (low formaldehyde emission).

Les composants et panneaux en bois que nous utilisons sont certifiés en classe E1 (faible émission de formaldéhyde).

Los componentes y paneles de madera que utilizamos están certificados en clase E1 (baja emisión de formaldehído).



I materiali di rivestimento dei nostri prodotti hanno superato il test EN 71-3 imposto dalla Comunità Europea sui giochi destinati alla prima infanzia e sono quindi certificati come non pericolosi per i bambini.

The coating materials of our products have passed the EN 71-3 test imposed by the European Community on games intended for early childhood and are therefore certified as not dangerous for children.

Les matériaux de revêtement de nos produits ont passé avec succès le test EN 71-3 imposé par la Communauté Européenne sur les jeux destinés à la petite enfance et sont donc certifiés non dangereux pour les enfants.

Los materiales de revestimiento de nuestros productos han superado la prueba EN 71-3 impuesta por la Comunidad Europea a los juegos destinados a la primera infancia y por tanto están certificados como no peligrosos para los niños.

AVVERTENZE

WARNINGS / AVERTISSEMENTS / ADVERTENCIAS

Target Point si riserva la facoltà di modificare in qualunque momento e senza preavviso le caratteristiche tecniche degli elementi usati nel presente catalogo. La ditta Target Point si riserva inoltre il diritto di apportare ai propri prodotti le modifiche che si riterranno necessarie o utili al fine di migliorarli senza pregiudicarne le caratteristiche essenziali.

Alcuni accessori presenti nelle immagini fotografiche non sono prodotti dalla ditta Target Point.

È vietata ogni riproduzione totale o parziale in Italia e all'estero.

Si prega di far riferimento al listino prezzi per informazioni dettagliate.

Target Point reserves the right to modify the technical characteristics of the elements used in this catalogue at any time and without notice. Target Point also reserves the right to make any changes to its products that are deemed necessary or useful in order to improve them without compromising their essential characteristics.

Some accessories shown in the photographs are not produced by Target Point.

Any total or partial reproduction in Italy and abroad is prohibited.

Please refer to the price list for detailed information.

Target Point se réserve le droit de modifier à tout moment et sans préavis les caractéristiques techniques des éléments utilisés dans ce catalogue. Target Point se réserve également le droit d'apporter à ses produits toutes les modifications jugées nécessaires ou utiles afin de les améliorer sans compromettre leurs caractéristiques essentielles.

Certains accessoires présentés dans les images photographiques ne sont pas produits par la société Target Point.

Toute reproduction totale ou partielle en Italie et à l'étranger est interdite.

Veillez faire référence à la liste de prix pour des informations détaillées.

Target Point se reserva el derecho de modificar las características técnicas de los elementos utilizados en este catálogo en cualquier momento y sin previo aviso. Target Point también se reserva el derecho de realizar cualquier cambio en sus productos que se considere necesario o útil para mejorarlos sin comprometer sus características esenciales.

Algunos accesorios que se muestran en las imágenes fotográficas no son producidos por la empresa Target Point.

Está prohibida toda reproducción total o parcial en Italia y en el extranjero.

Consultar siempre la lista de precios para información detallada.

USO E MANUTENZIONE

USE AND MAINTENANCE / UTILISATION ET ENTRETIEN / USO Y MANTENIMIENTO

TESSUTI

FABRICS / TEXTILES / TEJIDOS

L'esposizione continuata al sole, agli animali domestici o ad ambienti eccessivamente umidi e non correttamente areati può causare il deperimento delle finiture, delle imbottiture e di altre componenti. Per la pulizia si consiglia di usare un panno morbido pulito e inumidito con sola acqua (o al massimo con sapone neutro) facendo attenzione che esso non sia intriso di detersivi o alcool che potrebbero causare un danneggiamento alla finitura.

Continued exposure to the sun, pets or excessively humid and improperly ventilated environments can cause deterioration of finishes, padding and other components. For cleaning it is recommended to use a soft clean cloth moistened with water only (or at most with neutral soap) making sure that it is not soaked in detergents or alcohol which could damage the finish.

Une exposition continue au soleil, aux animaux domestiques ou à des environnements excessivement humides et mal ventilés peut entraîner une détérioration des finitions, du rembourrage et d'autres composants. Pour le nettoyage, il est recommandé d'utiliser un chiffon doux et propre imbibé d'eau uniquement (ou au maximum de savon neutre) en veillant à ce qu'il ne soit pas imbibé de détergents ou d'alcool qui pourraient endommager la finition.

La exposición continua al sol, las mascotas o los ambientes excesivamente húmedos y mal ventilados pueden provocar el deterioro de los acabados, el acolchado y otros componentes. Para la limpieza se recomienda utilizar un paño limpio y suave humedecido sólo con agua (o como máximo con jabón neutro) asegurándose de que no esté empapado en detergentes o alcohol que puedan dañar el acabado.

METALLI E LEGNI LACCATI, POLICARBONATO, POLIURETANO E POLIPROPILENE

LACQUERED WOODS AND METALS, POLYCARBONATE, POLYURETHANE AND POLYPROPYLENE

METAUX ET BOIS LAQUÉS, POLYCARBONAT, POLYURÉTHANE ET POLYPROPYLÈNE

METALES Y MADERAS LACADAS, POLICARBONATO, POLIURETANO Y POLIPROPILENO

L'esposizione continuata al sole, agli animali domestici o ad ambienti eccessivamente umidi e non correttamente areati può causare il deperimento delle finiture, delle imbottiture e di altre componenti. Per la pulizia si consiglia di usare un panno morbido pulito e inumidito con sola acqua (o al massimo con sapone neutro) facendo attenzione che esso non sia intriso di detersivi o alcool che potrebbero causare un danneggiamento alla finitura.

Continued exposure to the sun, pets or excessively humid and improperly ventilated environments can cause deterioration of finishes, padding and other components. For cleaning it is recommended to use a soft clean cloth moistened with water only (or at most with neutral soap) making sure that it is not soaked in detergents or alcohol which could damage the finish.

Une exposition continue au soleil, aux animaux domestiques ou à des environnements excessivement humides et mal ventilés peut entraîner une détérioration des finitions, du rembourrage et d'autres composants. Pour le nettoyage, il est recommandé d'utiliser un chiffon doux et propre imbibé d'eau uniquement (ou au maximum de savon neutre) en veillant à ce qu'il ne soit pas imbibé de détergents ou d'alcool qui pourraient endommager la finition.

La exposición continua al sol, las mascotas o los ambientes excesivamente húmedos y mal ventilados pueden provocar el deterioro de los acabados, el acolchado y otros componentes. Para la limpieza se recomienda utilizar un paño limpio y suave humedecido sólo con agua (o como máximo con jabón neutro) asegurándose de que no esté empapado en detergentes o alcohol que puedan dañar el acabado.

VETRO

GLASS / VERRE / CRISTAL

Per motivi strutturali è consigliato non sedersi sul piano, non fissare seggiolini, non spostare il tavolo afferrandolo dal piano, non colpire forte il piano con oggetti pesanti o appuntiti (martello, coltello). Eventuali macchie od aloni sui piani in vetro devono essere puliti con detersivi sgrassanti specifici per vetro.

For structural reasons it is advisable not to sit on the top, not to fix hanging baby seats to the top, not to move the table by grabbing it from the top, not to hit the top bluntly with heavy or sharp objects (for example with a hammer or knife). Any stains or halos on glass tops must be cleaned with degreasing glass-specific detergents.

Pour des raisons structurelles, il est conseillé de ne pas s'asseoir sur le plateau, de ne pas fixer des sièges bébé, de ne pas déplacer la table en la prenant par le plateau, de ne pas frapper brutalement le plateau avec des objets lourds ou pointus (par exemple avec un marteau ou couteau). Les taches ou auréoles sur les plateaux en verre doivent être nettoyées avec des détergents dégraissants spécifiques pour le verre.

Por razones estructurales, se recomienda no sentarse en la encimera, no fijar asientos para bebés, no mover la mesa agarrándola por la encimera, no golpear fuerte la encimera con objetos pesados o puntiagudos (por ejemplo, con un martillo o un cuchillo). Cualquier mancha o halo en las encimeras de cristal debe limpiarse con detersivos desengrasantes específicos para cristal.

GRES PORCELLANATO

PORCELAIN GRES STONEWARE / CÉRAMIQUE GRES / GRES PORCELANICO

Per motivi strutturali è consigliato non sedersi sul piano, non fissare seggiolini, non spostare il tavolo afferrandolo dal piano, non colpire forte il piano con oggetti pesanti o appuntiti (martello, coltello). Per la pulizia è possibile utilizzare detersivi non abrasivi, facendo attenzione però che la sostanza non finisca su altre componenti del prodotto che potrebbero rovinarsi, come la laccatura delle gambe e del telaio.

For structural reasons it is advisable not to sit on the top, not to fix hanging baby seats to the top, not to move the table by grabbing it from the top, not to hit the top bluntly with heavy or sharp objects (for example with a hammer or knife). For cleaning, even non-abrasive detergents can be used, making sure that the substance does not end up on other components of the product that could get damaged, such as the lacquering of the legs and the frame.

Pour des raisons structurelles, il est conseillé de ne pas s'asseoir sur le plateau, de ne pas fixer des sièges bébé, de ne pas déplacer la table en la prenant par le plateau, de ne pas frapper brutalement le plateau avec des objets lourds ou pointus (par exemple avec un marteau ou couteau). Pour le nettoyage, même des détergents non abrasifs peuvent être utilisés, en veillant à ce que la substance ne se retrouve pas sur d'autres composants du produit qui pourraient être endommagés, tels que le laquage des pieds et des coulisses.

Por razones estructurales, se recomienda no sentarse en la encimera, no fijar asientos para bebés, no mover la mesa agarrándola por la encimera, no golpear fuerte la encimera con objetos pesados o puntiagudos (por ejemplo, con un martillo o un cuchillo). Para la limpieza se pueden utilizar incluso detergentes no abrasivos, asegurándose de que la sustancia no vaya a parar a otros componentes del producto que podrían dañarse, como el lacado de las patas y del bastidor.

INFO UTILI

USEFUL INFO / INFOS UTILES / INFO ÚTIL

FILTRO PRODOTTI IN RETE

ONLINE PRODUCT FILTER / FILTRE PRODUITS EN LIGNE / FILTRO PRODUCTOS EN LÍNEA

Trovare i prodotti con le caratteristiche che hai in mente è ancora più semplice grazie alla possibilità di filtrare i risultati sul nostro sito! Provalo subito!

Finding the products with the features you have in mind is even easier thanks to the filter on our website! Try it now!

Trouver des produits avec les caractéristiques que vous avez en tête est encore plus facile grâce à la possibilité de filtrer les résultats sur notre site ! Essayez-le maintenant !

¡Encontrar productos con las características que tiene en mente es aún más fácil gracias al filtro de productos en nuestro sitio! ¡Pruébelo ahora mismo!



COMUNICAZIONI

NEWSLETTER / COMMUNICATIONS / BULETINES

Assicuratevi di essere iscritti alla nostra lista contatti per ricevere le comunicazioni aziendali ed essere sempre aggiornati sulle novità dell'azienda.

Make sure you are subscribed on our contact list to receive corporate communications and always be updated on company news.

Assurez-vous d'être inscrit sur notre liste de contacts pour recevoir les communications de l'entreprise et être toujours au courant des nouvelles de l'entreprise.

Asegúrese de estar registrado en nuestra lista de contactos para recibir comunicaciones corporativas y estar siempre actualizado sobre las novedades de la empresa.



PROMOZIONI

PROMOTIONS / PROMOTIONS / PROMOCIONES

Scopri le vantaggiose offerte valide fino ad esaurimento scorte nella sezione PROMOZIONI del nostro sito.

Discover the advantageous offers valid while stocks last in the PROMOTIONS section of our website.

Découvrez les offres avantageuses valables jusqu'à épuisement des stocks dans la section PROMOTIONS de notre site.

Descubra las ventajosas ofertas válidas hasta agotar existencias en la sección PROMOCIONES de nuestro sitio.



ORDINI

ORDERS / COMMANDES / PEDIDOS



vendite@targetpoint.it



sales@targetpoint.it

ASSISTENZE

HELP / SAV / INCIDENCIAS



help@targetpoint.it

CONTATTI

CONTACTS / CONTACTS / CONTACTOS



(0039) 0424219797



info@targetpoint.it



export@targetpoint.it

RETI SOCIALI

SOCIAL NETWORK / RESEAUX SOCIAUX / REDES SOCIALES



[targetpointdesign](#)



[targetpointsrl](#)



[TargetPointTube](#)



[@TargetTwitt](#)



[Target Point Srl](#)



[Target Point Arredamenti](#)



Target Point

Via Basse, 13/H
36056
Tezze sul Brenta (VI)
ITALY
tel +39 0424 219797
www.targetpoint.it
info@targetpoint.it



Sostieni la Fondazione Città della Speranza.
Perché sia sempre possibile diventare grandi.

Help us supporting Città della Speranza foundation.
Because everyone should have the opportunity to grow up.

art direction and styling
ROSSI & CO.
graphic design
ROSSI & CO.
photography
STUDIO INDOOR
colour separation
Z13
printed by
OGM
printed in Italy - JUNE 2022

DC148



Target Point
Via Basse, 13/H - 36056 Tezze sul Brenta (VI) ITALY - tel +39 0424 219797
www.targetpoint.it - info@targetpoint.it